



CLEVELAND STATE UNIVERSITY

Sign Standards Manual Updated 05/2024



Table of Contents

Sign Program Philosophy	ii
Introduction & Usage	iii
Contact Information	iv

SECTION 1

Graphic Standards

CSU Brand	2
Fonts	5
Symbols & Arrows	6
Colors & Materials	7
Nomenclature	8
ADA Standards	9
Ohio Building Code	12

SECTION 2

Sign Standards

Exterior Sign Family Overview	14
Interior Sign Family Overview	22

SECTION 3

● Exterior Sign Drawings

Orientation / Information	31
A1 Information/Map Kiosk Identification	34
B1 Primary Building ID/ Monument	
B2 Secondary Building ID	
B3 Building ID - Dimensional Letters	
B4 Building ID - Vinyl	
B5 Parking Structure/ Lot ID	
B6 Pedestrian Directional	
Regulatory	46
C1 Traffic Regulatory Pole	
Speciality / LEED®	48
D1 No Trespassing, Smoking, Firearms	
D2 Welcome	
D3 No Smoking	

SECTION 4

● Interior Sign Drawings

Orientation / Information	54
E1 Electronic Information Kiosk	
E2 Level Directory	
Directional	61
F1 Wall Directional	
F2 Overhead Directional	
F3 Free-Standing Directional	
Identification	67
G1 Flag Mounted ID	
G2 Public Convenience ID	
G3 Department ID	
G4 Public Room/Office ID	
G5 Operational Room ID	
Regulatory	76
H1 Evacuation Plan	
H2 Stairwell Egress/ Level ID	
H3 Stairwell Tactile Exit	
H4 Maximum Occupancy	
H5 Vinyl Message/ Graphics	
H6 Elevator Floor Level Elevator Identifier Tags	
● Donor Recognition Signs	81B
J1 Room Donor Plaques Tree Donor Plaque	
J2 Donor Name Plate	

SECTION 5

Appendix

Appendix A	83
Typical Sign Frame Construction Notebar Notice Holders	
Appendix B	84
Design Intent Drawings	
Appendix C	85
Fabrication Shop Drawings	

Sign Program Philosophy

For some, navigating an unfamiliar space for the first time can be stressful, especially in the complex university campus environment. An effective, consistent system of wayfinding tools can help those first-time visitors move confidently through facilities to reach their intended destination and provide a positive overall experience along the way.

Recognizing that Cleveland State University (CSU)'s signage is a direct extension of its brand (*see page 2*), the Sign Program detailed herein proudly displays institutional colors, fonts and brand elements. Sign materials and elements have been selected and designed in line with CSU's commitment to quality learning and living spaces.

Among the many University buildings, visitors will experience a variety of architectural environments. A uniform sign program eases wayfinding and reinforces sense of belonging by presenting consistent information to a visitor.

The quantity of interior signs needed to achieve a seamless wayfinding system requires a flexible design with ease of maintenance, updates, replacement and expansion. The CSU Sign Program takes a modular approach allowing for frequent and convenient message updates.

The CSU Interior Sign Program was developed with a diverse visitor-base in mind. From students, faculty and administrators to extended community members visiting campus buildings, the signage aims to communicate wayfinding information to *everyone*. The program conforms to the Americans with Disabilities Act (ADA) recommendations on signage (*see page 10*) and addresses all relevant building codes.

The success of CSU's Sign Program hinges upon consistent messaging and application; compliance with the signage program is mandatory.

Introduction & Usage

The purpose of this manual is to introduce the Cleveland State University Standard Signage & Wayfinding Program and provide instructions to those who may be planning or specifying signs for new buildings. This document will also serve as a guide for re-ordering signs – particularly Department or Room Identification – that may require regular replacement.

The Standard Sign Program was developed to provide consistency and uniformity across the campus and is the culmination of work by the Office of the University Architect, Marketing and the Signage and Wayfinding Consultant to provide a comprehensive system for the varying and expanding campus environments. It is a flexible sign system that will allow for ease in changing and expanding information within the program when necessary.

There may be instances where a nonstandard sign is necessary. This manual provides a standard for design intent. Any custom signs or deviations from the sign family must be approved by the Office of the University Architect.

INTENT

- » To guide visitors through Cleveland State University's campus to their destinations with ease.
- » To provide access to persons with disabilities by providing braille, tactile or visual signage as required by law.
- » To ensure that all current building codes, as they relate to signage, are addressed.
- » To provide an aesthetically appropriate and cost effective solution for the thousands of signs required on campus offering a versatile and flexible sign program that expands as CSU continues to grow.

USING THIS MANUAL

Section 1 Introduces the Graphic Standards for the Sign Program. It addresses the use of graphic elements, logos and symbols, fonts, colors, materials, and nomenclature used within the program.

Section 2 Introduces the Sign Family. It includes programming and usage information for each sign type.

Section 3 Provides Design Intent-level drawings for each sign type, specifying layouts, element sizes, materials and recommended fabrication and mounting methods. *Note: These drawings and notes are for the sole purpose of expressing visual design intent and are not intended for actual fabrication purposes.*

Section 4 Appendices include a comprehensive listing of building abbreviations and typical Performance Specifications for the signage detailed herein.

Contact Information

DESIGN, BUILD & CONSTRUCTION

For questions regarding the Cleveland State University Sign Program and Standards, please contact:

Office of the University Architect (OUA)

Mailing Address

Cleveland State University
2121 Euclid Avenue PS 235
Cleveland, OH 44115-2214

Campus Location

Plant Services, Room 235
1802 East 25th Street

216-687-2500

MARKETING & COMMUNICATIONS

For questions regarding any Cleveland State University branded communications, please contact University Marketing at: 216-687-2290.

Approved College logos available at:
www.csuohio.edu/marketing/logos

SIGNAGE & WAYFINDING CONSULTANTS

This manual was prepared by Studio Graphique, Inc. under the direction of the Cleveland State University Office of the University Architect.

SECTION 1

Graphic Standards

CSU Brand

Fonts

Symbols & Arrows

Colors & Materials

Nomenclature

ADA Standards

Ohio Building Code

SECTION 1

CSU Brand

Introduction & Seal

We all need to work together to spread the good news about Cleveland State. We are, fortunately, a collective force that includes not just marketing and public affairs professionals, but members of the faculty, administrators at all levels, staff members, alumni and students. The need to communicate our good news with a single, unified voice is critical in the increasingly competitive marketing environment of higher education.

– From University Graphic Identity Guidelines (2004)

OFFICIAL UNIVERSITY SEAL

The emblem of the University, the seal, is commonly used on buildings, official and formal documents and ceremonial materials. It is the university's official identifier and should be prominently and clearly displayed on all visual communications.

For additional information and specific University logo guidelines, go to: www.csuohio.edu/marketing/graphic-identity-guidelines



SECTION 1

CSU Brand

Seal Usage

SEAL COLORS

The logo may be reproduced in any of these colors:

- » University Green (PMS 342).
- » Black. The actual black is dependent upon the sign material and/or substrate. Refer to the Signage Colors & Materials (page 7) and individual sign type drawings.
- » White. The seal may be reversed out in all white on dark backgrounds. You may use different colored backgrounds or photographs as long as the logo is reversed out to all white and clearly distinguishable from the background. Contact the Office of University Communications and Marketing if you are unsure about logo size, background, position or placement.
- » When printing the seal as a graphic/decorative element, you may screen the all black or white seal to closely match the background.

The seal may not be altered or reconfigured.

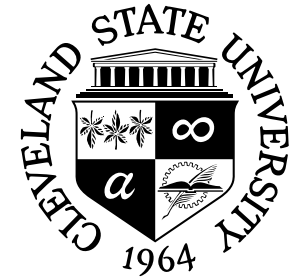

Reversed seal adjusted for use on dark backgrounds.



Ex. white or frosted decal

SECTION 1

CSU Brand

Seal Usage

SEAL SIZE

The University seal can be used at any size, but no smaller than 1.5 inches wide.



CLEAR SPACE

There should be 1X clear space on all sides of the seal where X is the height of the "A" letter, as shown. This may vary slightly between sign types and this is considered a guideline as opposed to a hard and fast rule.



PLACEMENT

The University seal may also bleed off an edge when being used as a graphic/decorative element. Do not obscure the seal so much that it is not easily identifiable as the CSU University seal.

The University seal may not be enclosed in boxes or other geometric shapes. Enclosing it in a circle is acceptable but not recommended. Contact the Office of University Architects for final seal approval.

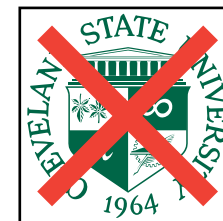
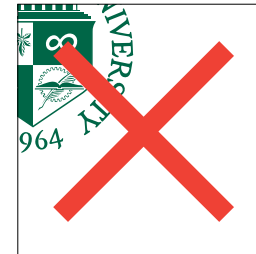

SECTION 1

Symbols & Arrows

SYMBOLS

Symbols, or pictograms, are an important tool in communicating to a diverse audience. Symbols cross language boundaries by employing images to identify and direct to public destinations and services. The CSU sign program uses several of the internationally-recognized symbols developed through a collaboration between the AIGA and the U.S. Department of Transportation between 1974 -1979.

These symbols have been selected for use with the CSU sign system. Any additional symbols should be reviewed by CSU prior to use.



ARROWS

The directional arrow selected for the sign program is legible and easily-recognized. It may be positioned in (8) different directions as shown.



SECTION 1

Colors & Materials

These represent CSU's primary sign color and materials palette. The colors make up the bulk of the colors utilized in all sign applications and are created through subsurface digital graphics or subsurface paint.

All materials specified as part of the CSU Sign Program were selected for their durability, quality, changeability and compliance.

The letter designations shown are used to indicate the color or finish of any component of a sign (see Section 3 Sign Drawings).

Follow the color ratios below as closely as possible to help ensure the right balance of color. Most visual materials should be dominated by white and accented with the other colors in the brand palette.

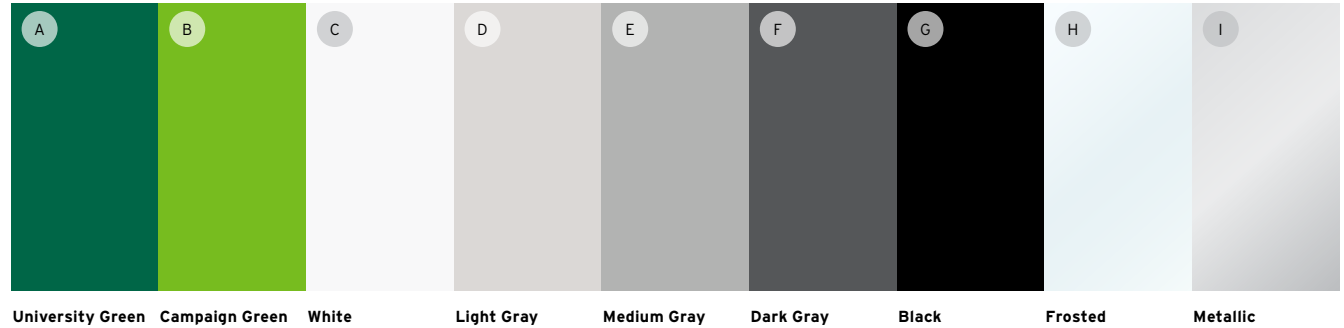

Pantone <i>PMS, Coated</i>	PMS 342	PMS 368		PMS Cool Gray 1	PMS 421	PMS 425		
Paint <i>Matthews</i>	MP11859 Summer Lawn	MP13525 Play-Doh Green	MP32071 White Wonder	MP07273 Graytint	MP03340 Grey Fog	MP13915 Neptunian Grey	MP42359 Vine Charcoal	41342SP Brushed Aluminum
<i>Sherwin-Williams</i>	SW 6748 Greens	SW 6923 Festival Green	SW 7006 Extra White	SW 7014 Eider White	SW 7065 Argos	SW 7076 Cyberspace	SW 6258 Tricorn Black	
Vinyl <i>3M Opaque Graphic Film</i>	7725-56 Dark Green	7725-196 Apple Green	7725-20 Matte White	7725 Pearl Gray	7725-31 Medium Gray	7725-41 Dark Gray	7725-22 Matte Black	
<i>3M Scotchlite Reflective Graphic Film</i>			680-10 White					
<i>3M Scotchcal Translucent Graphic Film</i>								AccuCut 351245 Glass Etch (decals)
Rowmark <i>ADA Alternative Substrate & Appliqué</i>						311-307 Charcoal Gray		3M 7725SE-314 Dusted Crystal (privacy film)

SECONDARY COLOR PALETTE

The colors at right have been selected to compliment the primary CSU color palette for use in expanded wayfinding materials such as building mapping.

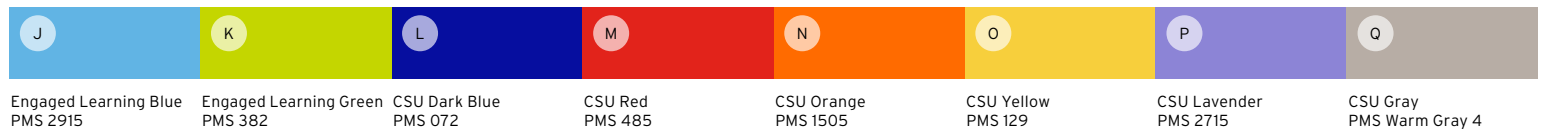

SECTION 1

Room Numbering, Nomenclature & Abbreviations

Consistent use of terminology and numbering conventions across campus is just as important to the success of the Sign Program as visual consistency.

Signage along the Innerlink should include 2-letter building code for clarity.

Building codes are not required on signs within freestanding buildings.

BUILDING ABBREVIATIONS

All CSU buildings names have a corresponding 2 letter abbreviation. These designations are now used on all room numbers and will appear regularly on interior signage. It is important to understand this system when navigating the University campuses. For a complete list of Buildings and their Abbreviations, see Appendix A (page 79).

Fenn Hall = FH
Julka Hall = JH
Student Center = SC

ROOM NUMBERING

Typical academic and administrative rooms consist of a 2 letter building abbreviation directly followed by a level and room number.

Do not use a hyphen (-) to separate the building abbreviation from the room number.

Office or rooms within suites may have a letter suffix added after the suite's room number. The suite letter is always separated from the room number by a hyphen (-).

FH 332

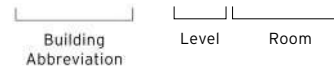

Building Abbreviation Level Room

FH 332-A

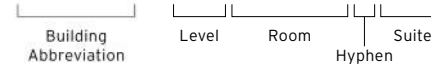

Building Abbreviation Level Room Hyphen Suite

SECTION 1

The 2010 Americans with Disabilities Act Standards for Accessible Design

“Each facility or part of a facility constructed by, on behalf of, or for the use of a public entity shall be designed and constructed in such manner that the facility or part of the facility is readily accessible to and usable by individuals with disabilities...”

28 CFR 35.151 (a)(1)

Note: It is the fabricator's responsibility to ensure the built CSU sign program is ADA compliant.

The 2010 Americans with Disabilities Act Standards for Accessible Design (hereafter referred to as the ADA Standards) guided the planning & design of the CSU Interior Sign program outlined herein.

The following highlights applicable code excerpts that were particularly influential in these accessible design-related decisions.

For further information on the ADA Standards or the official full-text version, visit the U.S. Department of Justice's ADA website: <http://www.ada.gov/>

ADA CHAPTER 2: SCOPING REQUIREMENTS

216: Signs

216.2 Designations. Interior and exterior signs identifying permanent rooms and spaces shall comply with 703.1, 703.2, and 703.5. Where pictograms are provided as designations of permanent interior rooms and spaces, the pictograms shall comply with 703.6 and shall have text descriptors complying with 703.2 and 703.5. **EXCEPTION:** Exterior signs that are not located at the door to the space they serve shall not be required to comply with 703.2.

Advisory 216.2 Designations. Section 216.2 applies to signs that provide designations, labels, or names for interior rooms or spaces where the sign is not likely to change over time. Examples include interior signs labeling restrooms, room and floor numbers or letters, and room names. Tactile text descriptors are required for pictograms that are provided to label or identify a

permanent room or space. Pictograms that provide information about a room or space, such as “no smoking,” occupant logos, and the International Symbol of Accessibility, are not required to have text descriptors.

216.3 Directional and Informational Signs. Signs that provide direction to or information about interior spaces and facilities of the site shall comply with 703.5.

Advisory 216.3 Directional and Informational Signs. Information about interior spaces and facilities includes rules of conduct, occupant load, and similar signs. Signs providing direction to rooms or spaces include those that identify egress routes.

ADA CHAPTER 7: COMMUNICATION ELEMENTS AND FEATURES

703: Signs

703.1 General. Signs shall comply with 703. Where both visual and tactile characters are required, either one sign with both visual and tactile characters, or two separate signs, one with visual, and one with tactile characters, shall be provided.

703.2 Raised Characters. Raised characters shall comply with 703.2 and shall be duplicated in braille complying with 703.3. Raised characters shall be installed in accordance with 703.4.

Advisory 703.2 Raised Characters. Signs that are designed to be read by touch should not have sharp or abrasive edges.

703.2.1 Depth. Raised characters shall be 1/32 inch (0.8 mm) minimum above their background.

703.2.2 Case. Characters shall be uppercase.

703.2.3 Style. Characters shall be sans serif. Characters shall not be italic, oblique, script, highly decorative, or of other unusual forms.

703.2.4 Character Proportions. Characters shall be selected from fonts where the width of the uppercase letter “O” is 55 percent minimum and 110 percent maximum of the height of the uppercase letter “I”.

703.2.5 Character Height. Character height measured vertically from the baseline of the character shall be 5/8 inch (16 mm) minimum and 2 inches (51 mm) maximum based on the height of the uppercase letter “I”.

EXCEPTION: Where separate raised and visual characters with the same information are provided, raised character height shall be permitted to be 1/2 inch (13 mm) minimum.

703.2.6 Stroke Thickness. Stroke thickness of the uppercase letter “I” shall be 15 percent maximum of the height of the character.

703.2.7 Character Spacing. Character spacing shall be measured between the two closest points of adjacent raised characters within a message, excluding word spaces. Where characters have rectangular cross sections, spacing between individual raised characters shall be 1/8 inch (3.2 mm) minimum and 4 times the raised character stroke width maximum. Where characters have other cross sections, spacing between individual raised characters shall be 1/16 inch (1.6 mm) minimum and 4 times the raised character stroke width maximum at the base of the cross sections, and 1/8 inch (3.2 mm) minimum and 4 times the raised character stroke width maximum at the top of the cross sections. Characters shall be separated from raised borders and decorative elements 3/8 inch (9.5 mm) minimum.

703.2.8 Line Spacing. Spacing between the baselines of separate lines of raised characters within a message shall be 135 percent minimum and 170 percent maximum of the raised character height.

703.3 Braille. Braille shall be contracted (Grade 2) and shall comply with 703.3 and 703.4.

703.3.1 Dimensions and Capitalization. Braille dots shall have a domed or rounded shape and shall comply with Table 703.3.1. The indication of an uppercase letter or letters shall only be used

before the first word of sentences, proper nouns and names, individual letters of the alphabet, initials, and acronyms.

TABLE 703.3.1 BRAILLE DIMENSIONS

Measurement Range	Minimum in Inches Maximum in Inches
Dot base diameter	0.059 (1.5 mm) to 0.063 (1.6 mm)
Distance between two dots in the same cell ¹	0.090 (2.3 mm) to 0.100 (2.5 mm)
Distance between corresponding dots in adjacent cells ¹	0.241 (6.1 mm) to 0.300 (7.6 mm)
Dot height	0.025 (0.6 mm) to 0.037 (0.9 mm)
Distance between corresponding dots from one cell directly below ¹	0.395 (10mm) to 0.400 (10.2 mm)

¹ Measured center to center.

703.3.2 Position. Braille shall be positioned below the corresponding text. If text is multi-lined, braille shall be placed below the entire text. Braille shall be separated 3/8 inch (9.5 mm) minimum from any other tactile characters and 3/8 inch (9.5 mm) minimum from raised borders and decorative elements.

EXCEPTION: Braille provided on elevator car controls shall be separated 3/16 inch (4.8 mm) minimum and shall be located either directly below or adjacent to the corresponding raised characters or symbols.

703.4 Installation Height and Location. Signs with tactile characters shall comply with 703.4.

703.4.1 Height Above Finish Floor or Ground. Tactile characters on

signs shall be located 48 inches (1220 mm) minimum above the finish floor or ground surface, measured from the baseline of the lowest tactile character and 60 inches (1525 mm) maximum above the finish floor or ground surface, measured from the baseline of the highest tactile character.

EXCEPTION: Tactile characters for elevator car controls shall not be required to comply with 703.4.1.

703.4.2 Location. Where a tactile sign is provided at a door, the sign shall be located alongside the door at the latch side. Where a tactile sign is provided at double doors with one active leaf, the sign shall be located on the inactive leaf. Where a tactile sign is provided at double doors with two active leaves, the sign shall be located to the right of the right hand door. Where there is no wall space at the latch side of a single door or at the right side of double doors, signs shall be located on the nearest adjacent wall. Signs containing tactile characters shall be located so that a clear floor space of 18 inches (455 mm) minimum by 18 inches (455 mm) minimum, centered on the tactile characters, is provided beyond the arc of any door swing between the closed position and 45 degree open position.

EXCEPTION: Signs with tactile characters shall be permitted on the push side of doors with closers and without hold-open devices.

703.5 Visual Characters. Visual characters shall comply with 703.5.

EXCEPTION: Where visual characters comply with 703.2 and are accompanied

by braille complying with 703.3, they shall not be required to comply with 703.5.2 through 703.5.9.

703.5.1 Finish and Contrast. Characters and their background shall have a non-glare finish. Characters shall contrast with their background with either light characters on a dark background or dark characters on a light background.

Advisory 703.5.1 Finish and Contrast. Signs are more legible for persons with low vision when characters contrast as much as possible with their background. Additional factors affecting the ease with which the text can be distinguished from its background include shadows cast by lighting sources, surface glare, and the uniformity of the text and its background colors and textures.

703.5.2 Case. Characters shall be uppercase or lowercase or a combination of both.

703.5.3 Style. Characters shall be conventional in form. Characters shall not be italic, oblique, script, highly decorative, or of other unusual forms.

703.5.4 Character Proportions. Characters shall be selected from fonts where the width of the uppercase letter "O" is 55 percent minimum and 110 percent maximum of the height of the uppercase letter "I".

703.5.5 Character Height. Minimum character height shall comply with Table 703.5.5. Viewing distance shall be measured as the horizontal distance between the character and an obstruction preventing further approach towards the sign. Character height shall be based on the uppercase letter "I".

TABLE 703.5.5 VISUAL CHARACTER HEIGHT

Height to Finish Floor or Ground From Baseline of Character: 40 inches (1015 mm) to less than or equal to 70 inches (1780 mm)

Horizontal Viewing Distance: less than 72 inches (1830 mm)

Minimum Character Height: 5/8 inch (16 mm)

Horizontal Viewing Distance: 72 inches (1830 mm) and greater

Minimum Character Height: 5/8 inch (16 mm), plus 1/8 inch (3.2 mm) per foot (305 mm) of viewing distance above 72 inches (1830 mm)

Height to Finish Floor or Ground From Baseline of Character: Greater than 70 inches (1780 mm) to less than or equal to 120 inches (3050 mm)

Horizontal Viewing Distance: less than 180 inches (4570 mm)

Minimum Character Height: 2 inches (51 mm)

Horizontal Viewing Distance: 180 inches (4570 mm) and greater

Minimum Character Height: 2 inches (51 mm), plus 1/8 inch (3.2 mm) per foot (305 mm) of viewing distance above 180 inches (4570 mm)

Height to Finish Floor or Ground From Baseline of Character: greater than 120 inches (3050 mm)

Horizontal Viewing Distance: less than 21 feet (6400 mm)

Minimum Character Height: 3 inches (75 mm)

Horizontal Viewing Distance: 21 feet (6400 mm) and greater

Minimum Character Height: 3 inches (75 mm), plus 1/8 inch (3.2 mm) per foot

(305 mm) of viewing distance above 21 feet (6400 mm)

703.5.6 Height From Finish Floor or Ground. Visual characters shall be 40 inches (1015 mm) minimum above the finish floor or ground.

EXCEPTION: Visual characters indicating elevator car controls shall not be required to comply with 703.5.6.

703.5.7 Stroke Thickness. Stroke thickness of the uppercase letter "I" shall be 10 percent minimum and 30 percent maximum of the height of the character.

703.5.8 Character Spacing. Character spacing shall be measured between the two closest points of adjacent characters, excluding word spaces. Spacing between individual characters shall be 10 percent minimum and 35 percent maximum of character height.

703.5.9 Line Spacing. Spacing between the baselines of separate lines of characters within a message shall be 135 percent minimum and 170 percent maximum of the character height.

703.6 Pictograms. Pictograms shall comply with 703.6.

703.6.1 Pictogram Field. Pictograms shall have a field height of 6 inches (150 mm) minimum. Characters and braille shall not be located in the pictogram field.

703.6.2 Finish and Contrast. Pictograms and their field shall have a non-glare finish. Pictograms shall contrast with their field with either a light pictogram on a dark field or a dark pictogram on a light field.

Advisory 703.6.2 Finish and Contrast. Signs are more legible for persons with low vision when characters contrast as much as possible with their background. Additional factors affecting the ease with which the text can be distinguished from its background include shadows cast by lighting sources, surface glare, and the uniformity of the text and background colors and textures.

703.6.3 Text Descriptors. Pictograms shall have text descriptors located directly below the pictogram field. Text descriptors shall comply with 703.2, 703.3 and 703.4.

703.7 Symbols of Accessibility. Symbols of accessibility shall comply with 703.7.

703.7.1 Finish and Contrast. Symbols of accessibility and their background shall have a non-glare finish. Symbols of accessibility shall contrast with their background with either a light symbol on a dark background or a dark symbol on a light background.

Advisory 703.7.1 Finish and Contrast. Signs are more legible for persons with low vision when characters contrast as much as possible with their background. Additional factors affecting the ease with which the text can be distinguished from its background include shadows cast by lighting sources, surface glare, and the uniformity of the text and background colors and textures.

703.7.2 Symbols.

703.7.2.1 International Symbol of Accessibility. The International Symbol of Accessibility shall comply with Figure 703.7.2.1.



Figure 703.7.2.1 International Symbol of Accessibility

703.7.2.2 International Symbol of TTY. The International Symbol of TTY shall comply with Figure 703.7.2.2.



Figure 703.7.2.2 International Symbol of TTY

703.7.2.3 Volume Control Telephones. Telephones with a volume control shall be identified by a pictogram of a telephone handset with radiating sound waves on a square field such as shown in Figure 703.7.2.3.



Figure 703.7.2.3 Volume Control Telephone

703.7.2.4 Assistive Listening Systems. Assistive listening systems shall be identified by the International Symbol of Access for Hearing Loss complying with Figure 703.7.2.4.



Figure 703.7.2.4 International Symbol of Access for Hearing Loss

Ohio Building Code

Note: It is the fabricator's responsibility to ensure the built CSU sign program is Ohio Building Code compliant.

The following highlights applicable code excerpts that were particularly influential in these accessible design-related decisions.

For further information on the Ohio Building Code or the official full-text version, visit the Ohio Department of Commerce website:
<http://www.com.ohio.gov/dico/bbs>

2011 OHIO FIRE CODE / OHIO ADMINISTRATIVE CODE 1301:7-7-10 - MEANS OF EGRESS

Section 1004 Occupant Load

(3) 1004.3 Posting of occupant load.

Every room or space that is an assembly occupancy shall have the occupant load of the room or space posted in a conspicuous place, near the main exit or exit access doorway from the room or space. Posted signs shall be of an approved legible permanent design and shall be maintained by the owner or authorized agent.

Section 1007 Accessible Means of Egress

(9) 1007.9 Signage. Signage indicating special accessibility provisions shall be provided as follows:

- (a) Each door providing access to an area of refuge from an adjacent floor area shall be identified by a sign stating: "AREA OF REFUGE."
- (b) Each door providing access to an exterior area for assisted rescue shall be identified by a sign stating: "EXTERIOR AREA FOR ASSISTED RESCUE."

Signage shall comply with the ICC A11 7.1 as listed in rule 1301:7-7-47 of the Administrative Code requirements for visual characters and include the "International Symbol of Accessibility." Where exit sign illumination is required by paragraph (K)(2)(1011.2) of this rule, the signs shall be illuminated. Additionally, tactile signage complying with ICC A11 7.1 as listed in rule 1301:7-7-47 of the Administrative Code shall be located at each door to an area of refuge and exterior area for assisted rescue in accordance with paragraph (K)(3)(1011.3) of this rule.

(10) 1007.10 Directional signage.

Direction signage indicating the location of the other means of egress and which are accessible means of egress shall be provided at the following:

- (a) At exits serving a required accessible space but not providing an approved accessible means of egress.
- (b) At elevator landings.
- (c) Within areas of refuge.

OHIO BUILDING CODE (BASED ON THE IBC 2009)

1011.3 Tactile exit signs. A tactile sign stating EXIT and complying with Chapter 11 shall be provided adjacent to each door to an area of refuge, an exterior area for assisted rescue, an exit stairway, an exit ramp, an exit passageway and the exit discharge.

OHIO BUILDING CODE (BASED ON THE IBC 2009)

1022.7 Discharge identification.

A stairway in an exit enclosure shall not continue below its level of exit discharge unless an approved barrier is provided at the level of exit discharge to prevent persons from unintentionally continuing into levels below. Directional exit signs shall be provided as specified in Section 1011.

1022.8 Floor identification signs.

A sign shall be provided at each floor landing in exit enclosures connecting more than three stories designating the floor level, the terminus of the top and bottom of the exit enclosure and the identification of the stair or ramp. The signage shall also state the story of, and the direction to, the exit discharge and the availability of roof access from the enclosure for the fire department. The sign shall be located 5 feet (1524 mm) above the floor landing in a position that is readily visible when the doors are in the open and closed positions. Floor level identification signs in tactile characters complying with Chapter 11 shall be located at each floor level landing adjacent to the door leading from the enclosure into the corridor to identify the floor level.

1022.8.1 Signage requirements.

Stairway identification signs shall comply with Chapter 11 and all of the following requirements:

1. The signs shall be a minimum size of 18 inches (457 mm) by 12 inches (305 mm).
2. The letters designating the identification of the stair enclosure shall be a minimum of 1 1/2 inches (38 mm) in height.
3. The number designating the floor level shall be a minimum of 5 inches (127 mm) in height and located in the center of the sign.
4. All other lettering and numbers shall be a minimum of 1 inch (25 mm) in height.
5. Characters and their background shall have a nonglare finish. Characters shall contrast with their background, with either light characters on a dark background or dark characters on a light background.
6. When signs required by Section 1022.8 are installed in interior exit enclosures of buildings subject to Section 1024, the signs shall be made of the same materials as required by Section 1024.4.

SECTION 2

Sign Standards

-
- Exterior Sign Family Overview (A-D)
 - Interior Sign Family Overview (E-H)
 - Donor Recognition Signs (J)
-

Sign Standards

Exterior Sign Family Overview

SECTION 2

Exterior Sign Family

Orientation / Information



A1

Information/Map Kiosk

5'-8" w x 6'-10" h x 6" d

Freestanding single- or double-sided internally illuminated cabinet sign

Provides location for campus information and map display

SECTION 2

Exterior Sign Family

Identification



B1

Primary Building ID Monument

Freestanding

10'-0" w x 3'-2" h x 9" d

Double-sided internally illuminated monument sign

Identifies building name and address

Sign size may vary based on the amount of information (see page 35)

SECTION 2

Exterior Sign Family

Identification

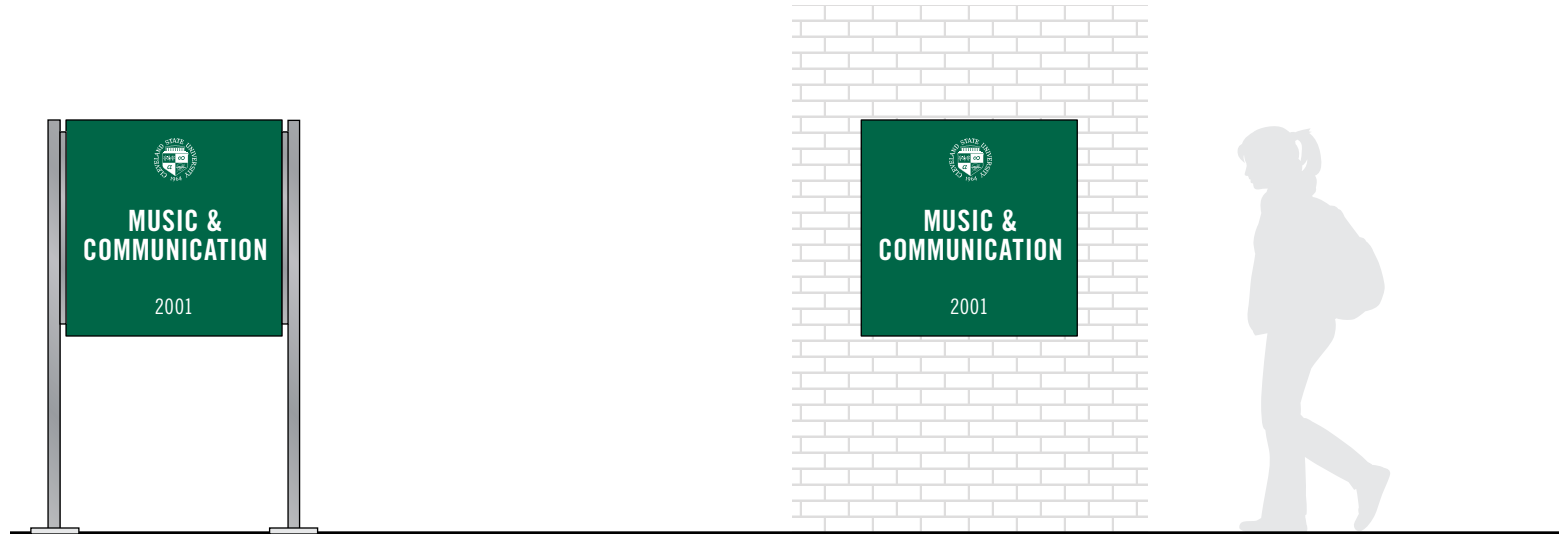

B2

Secondary Building ID

Freestanding

3'-9" w x 5'-9" h x 5" d

Single- or double-sided internally illuminated sign

Identifies building name and address

Sign size may vary based on the amount of information

B2.1

Secondary Building ID

Wall-Mounted

3'-0" w x 3'-0" h x 5" d

Single-sided internally illuminated sign

Identifies building name and address

Sign size may vary based on the amount of information

SECTION 2

Exterior Sign Family

Identification

JOSEPH E. SMITH
CENTER FOR INNOVATION
IN MEDICAL PROFESSIONS

JOSEPH E. SMITH
CENTER FOR INNOVATION
IN MEDICAL PROFESSIONS



Dept. of
Africana Studies

Ex. Department ID decal

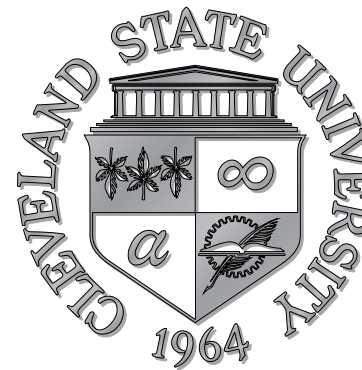

Music &
Communication

Ex. Building ID decal

B3

Building ID Dimensional Letters

Dimensions will vary

Painted fabricated or cut aluminum letters mounted to wall, building or canopy

May identify a speciality destination or donor recognition

May be back-lit

Other Examples

Dimensions will vary

Painted fabricated or cut aluminum seal mounted to wall or building

Small dimensional seal with mounting background (top example)

May be back-lit

B4

Building ID Vinyl

Dimensions will vary

Cut frosted vinyl applied to glass doors or sidelights

May identify specialty destinations, departments or buildings

SECTION 2

Exterior Sign Family

Identification



B5 B6

Parking Structure / Lot ID
Freestanding

3'-0" w x 7'-3" h x 7" d

Single- or double-sided internally illuminated sign

Identifies parking lot location and permit designations



B5.1

Parking Structure / Lot ID
Flag-mounted

3'-0" w x 6'-0" h x 7" d

Single- or double-sided internally illuminated sign

Identifies parking lot location and permit designations

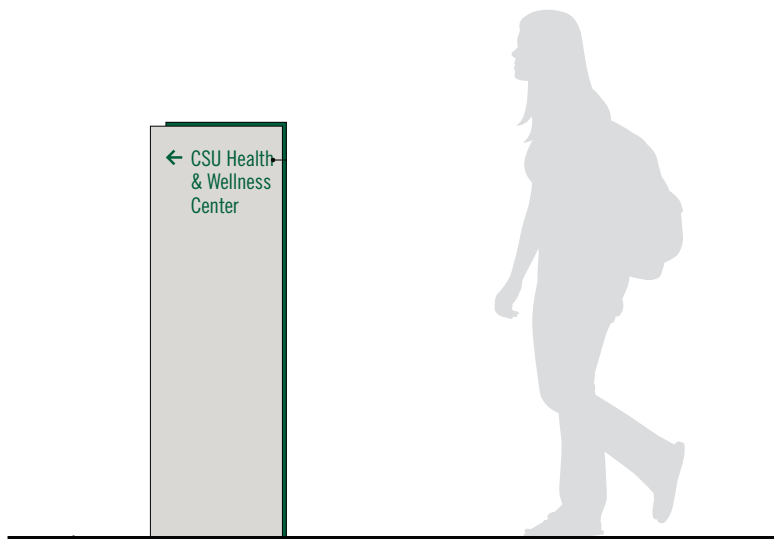

B6 PEDESTRIAN DIRECTIONAL

SECTION 2

Exterior Sign Family

Regulatory

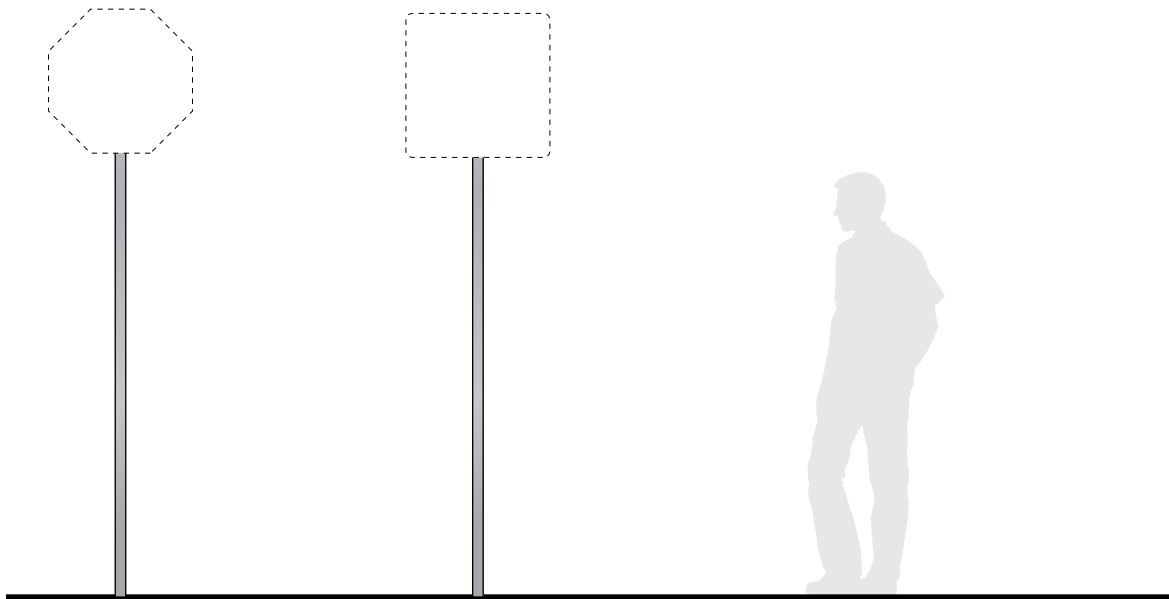

C1

Traffic Regulatory Post

2" square x 8'-0" h post

Painted aluminum square post for all regulatory signs

SECTION 2

Exterior Sign Family

Speciality / LEED®

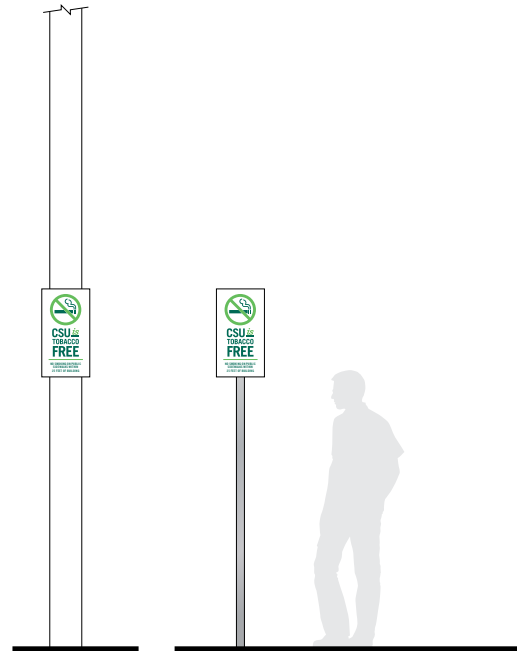

D1

No Trespassing, Smoking, Firearms

10" w x 8" h

Vinyl decal provides instructions as needed, placed on exterior of doors

Position will vary upon number of doors

D2

Welcome

10" w x 8 1/2" h

Vinyl decal welcomes visitors to building

Position will vary upon number of doors

D3

No Smoking Pole-Mounted

1'-0" w x 1'-10" h

Single-sided mounted to existing pole

Provides instructions as needed

D3.1

No Smoking Post-Mounted

1'-0" w x 1'-10" h

Single-sided post-mounted panel sign on painted aluminum square post

Provides instructions as needed

Sign Standards

Interior Sign Family Overview

SECTION 2

Interior Sign Family

Orientation / Information

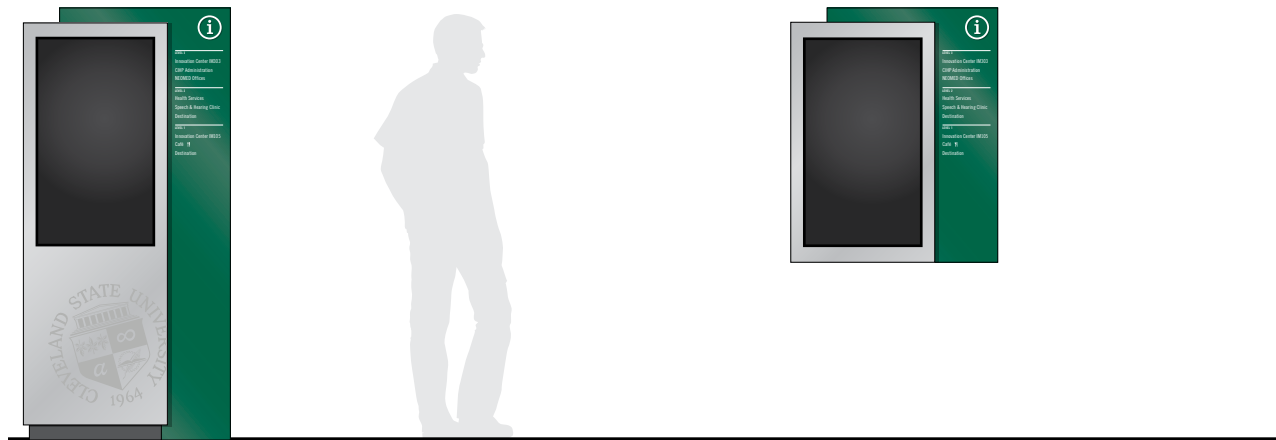

E1

Electronic Information Kiosk Freestanding

2'-10 1/2"w x 6'-0"h x 7"d

Electronic free-standing kiosk found at Building entry points. To be used where space permits or if a wall-mounted orientation kiosk (F1.1) would not be appropriate per building architecture.

E1.1

Electronic Information Kiosk Wall-Mounted

2'-10 1/2"w x 3'-6 3/8"h x 4"d

Wall-mounted kiosk found at building entry points. To be used where wall space permits and at conspicuous location near entry.

E2

Level Directory Wall-Mounted

2'-4"w x 3'-4"h

Wall-mounted directory found at entries or main points of vertical circulation (stairs, elevators and escalators)

May be used in addition to or in lieu of electronic kiosks

LEVEL 3
Innovation Center
CIMP Administration
NEOMED Offices
LEVEL 2
Health Services
Speech & Hearing Clinic
Destination
LEVEL 1
Innovation Center
Café H
Destination

SECTION 2

Interior Sign Family

Directional

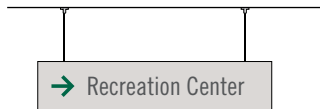
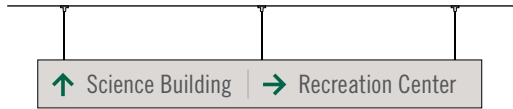
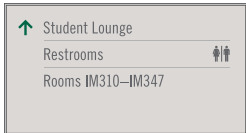

F1

Wall Directional

1'-3 1/4" w x varies

Changeable framed wall-mounted plaque

Sign width is consistent, height varies based on quantity of messages

F2

Overhead Directional Hanging

varies x 8" h

Single- or double-sided overhead hanging panel

Directs to primary public destinations in high-traffic areas or large scale corridors where ceiling heights allow for required clearance

F2.1

Overhead Directional Ceiling-Mounted

varies x 8" h

Single- or double-sided overhead ceiling mounted panel

Directs to primary public destinations in high-traffic areas or large scale corridors where ceiling heights allow for required clearance

F3

Free-Standing Directory

1'-6 1/2" w x 4'-11" h x 1 1/2" d

Double-sided panel sign found at entries or main points of vertical circulation (stairs, elevators and escalators)

Directs to primary destinations

May contain map of building

SECTION 2

Interior Sign Family

Identification

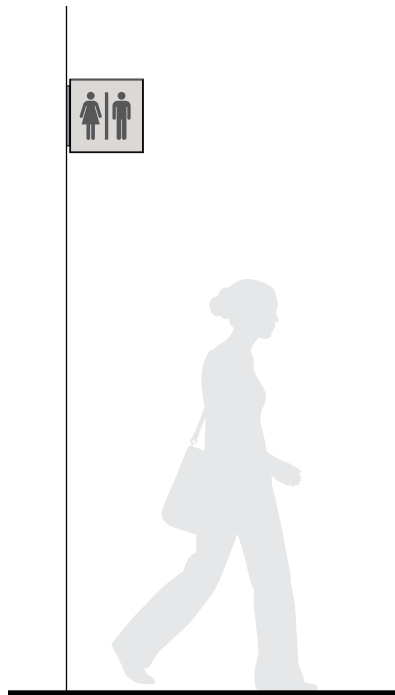

G1

Flag-Mounted ID

1'-0 1/4" w x 1'-0 1/4" h

Double-sided, flag-mounted panel sign with frame

Identifies public conveniences where ceiling height permits

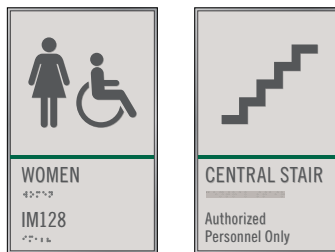

G2

Public Convenience ID

6 1/4" w x 10 1/4" h

Wall-mounted, ADA-compliant identification plaque with frame found at all public amenities such as restrooms, elevators and stairs

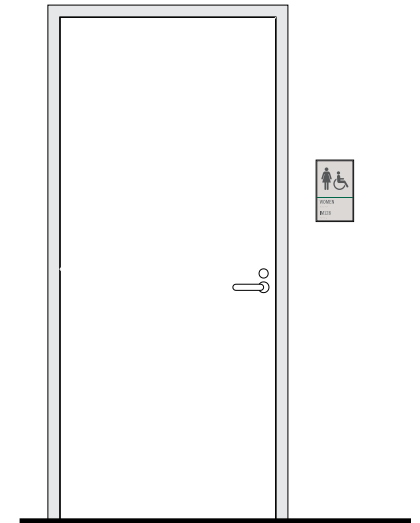

Typical Public Convenience ID Mounting (G2)

See section 4 Interior Sign Drawings for mounting details specific to each sign type

SECTION 2

Interior Sign Family

Identification

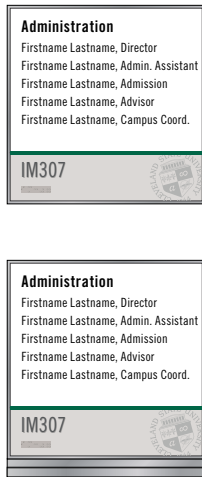
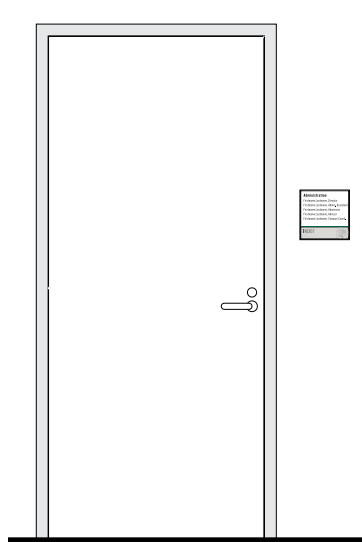

Typical Department ID Mounting (G3)

See section 4 Interior Sign Drawings for mounting details specific to each sign type

G3

Department ID

8 1/4" w x 8 1/4" h

Wall-mounted plaque with frame and snap-in lens containing ADA-compliant tactile suite number and Braille, found at entrances to Department Offices or groupings of smaller rooms/offices

Paper insert allows for custom message

Optional notebar provides opportunity for temporary posting of information

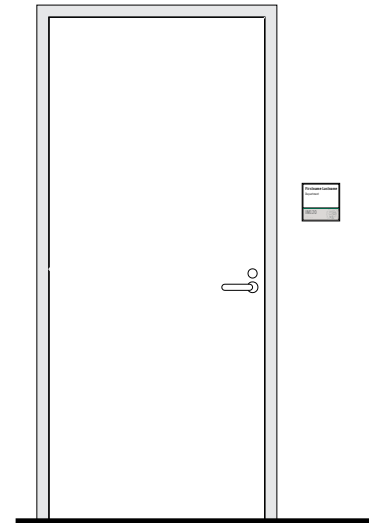
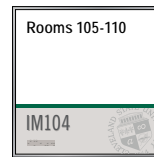

Typical Room ID Mounting (G4)

See section 4 Interior Sign Drawings for mounting details specific to each sign type

G4

Public Room/Office ID

6 1/4" w x 6 1/4" h

Wall-mounted plaque with frame and snap-in lens containing ADA-compliant tactile suite number and Braille, found at entrances of individual offices

Paper insert allows for custom message

Optional notebar provides opportunity for temporary posting of information, to be specified at most offices, conference rooms and classrooms

SECTION 2

Interior Sign Family

Identification



G5

Operational Room ID Wall-Mounted

6" w x 4 1/2" h

Rectangular wall-mounted plaque with tactile room number and Braille

Identifies non-public spaces such as electrical and mechanical rooms

May be used to identify other spaces

G6

Name Plate

6 1/4" w x 2 1/2" h

Wall or desk-mounted plaque with frame, snap-in lens and updatable paper insert

Identifies workstations or office spaces without a door



Typical Room ID Mounting (G5)

See section 4 Interior Sign Drawings for mounting details specific to each sign type

SECTION 2

Interior Sign Family

Regulatory



H1

Evacuation Plan
Wall-Mounted

11 1/4" w x 1'-1 1/4" h

Wall-mounted plaque with snap-in panel

Provides emergency egress information at elevators and assembly spaces

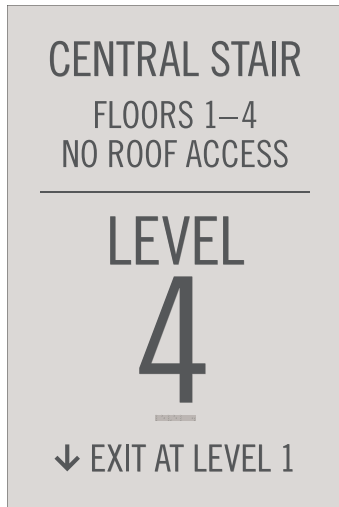

H2

Inside Stairwell Egress/Level ID
Wall-Mounted

1'-2" w x 1'-9" h

Large wall-mounted plaque with tactile level number and Braille

Identifies current level within stairwells and may provide egress information for buildings with greater than 3 levels per Ohio Building code



H3

Inside Stairwell Tactile Exit
Wall-Mounted

6" w x 4 1/2" h

Rectangular wall-mounted plaque that identifies exits per Ohio Building code

Provides tactile information and Braille

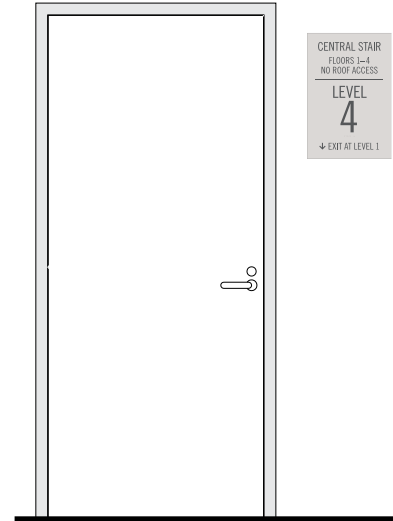

Typical Inside Stairwell Egress/
Level ID Mounting (H2)

See section 4 Interior Sign Drawings for mounting details specific to each sign type



H4

Maximum Occupancy
Wall-Mounted

6" w x 4 1/2" h

Identifies maximum occupancy load of room

SECTION 2

Interior Sign Family

Regulatory
Donor Recognition

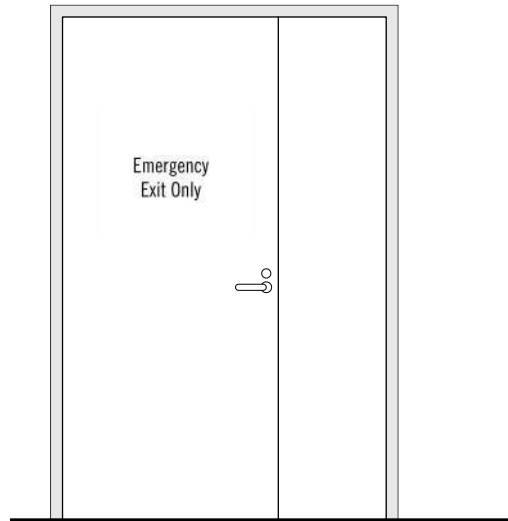

H5

Vinyl Messages/Graphics

Dimensions will vary

Custom messages/graphics must be approved by the Office of the University Architect (OUA) and Marketing

Refer to sign type B4 for Department ID design



H6

Elevator Floor Level Tag

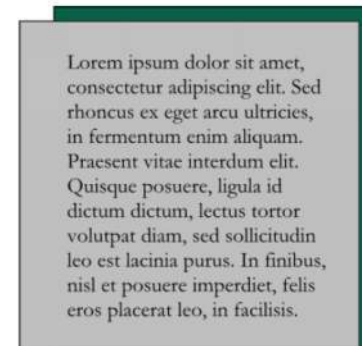
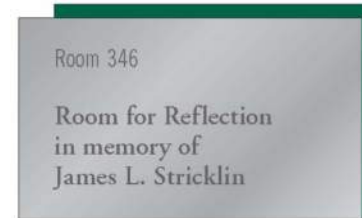
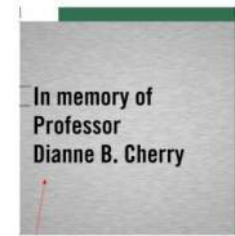

J1

Room Donor Plaques



J2

Donor Name Plate

● Exterior Sign Drawings

Orientation / Information

Identification

Regulatory

Speciality / LEED®

SECTION 3

Exterior Sign Drawings

Orientation / Information

SECTION 3

A1 Information/Map Kiosk
Freestanding

ALL map kiosks shall be 2-sided unless placement is such that it cannot be viewed from both sides

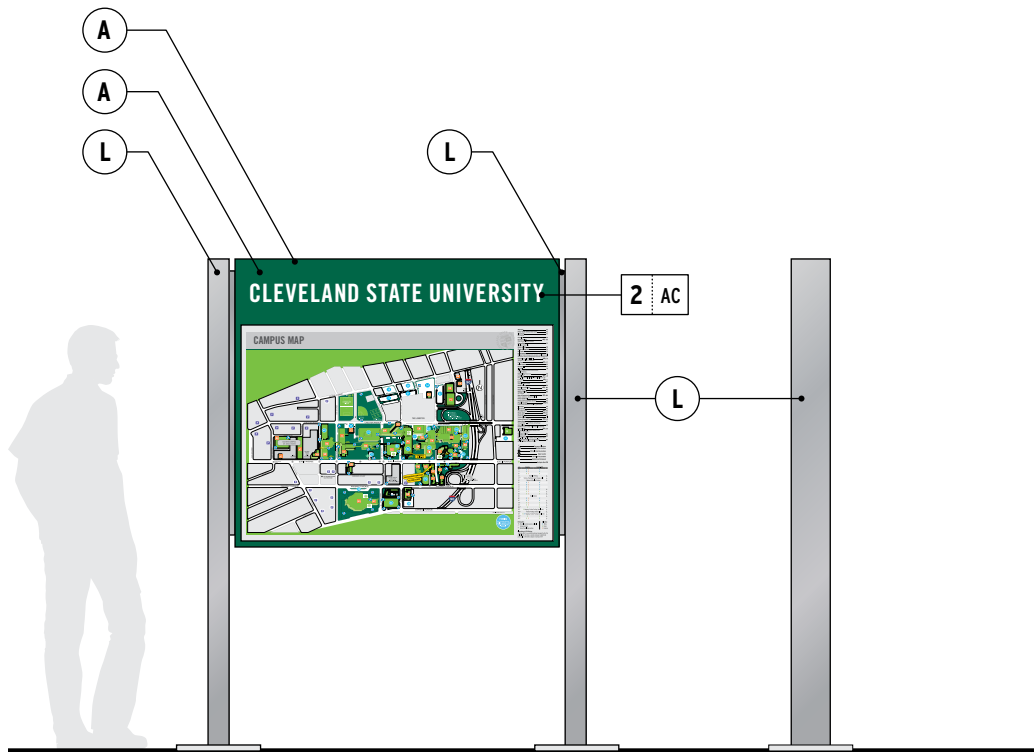

FRONT ELEVATION
SCALE: 3/8" = 1'-0"

SIDE ELEVATION
SCALE: 3/8" = 1'-0"

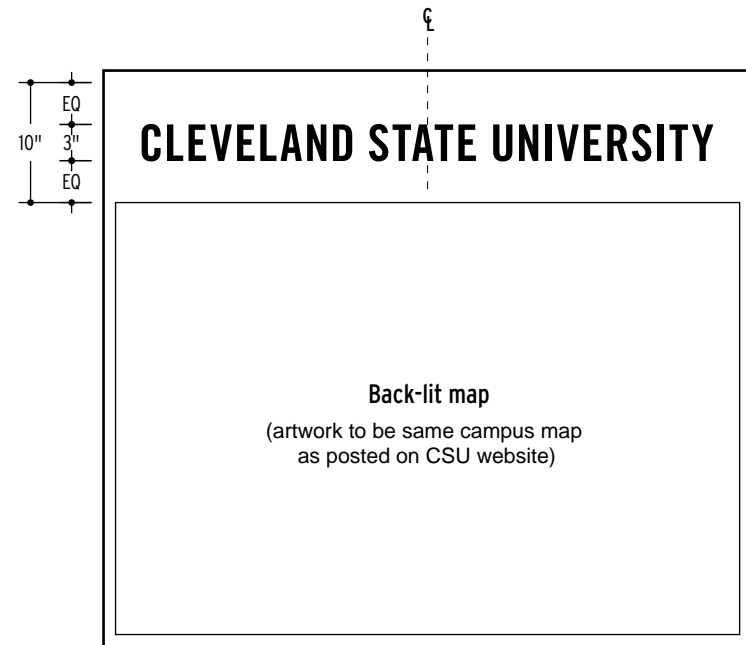

CLEVELAND STATE UNIVERSITY

Back-lit map
(artwork to be same campus map as posted on CSU website)

FRONT ELEVATION LAYOUT
SCALE: 3/4" = 1'-0"

SECTION 3

A1 Information/Map Kiosk
Freestanding

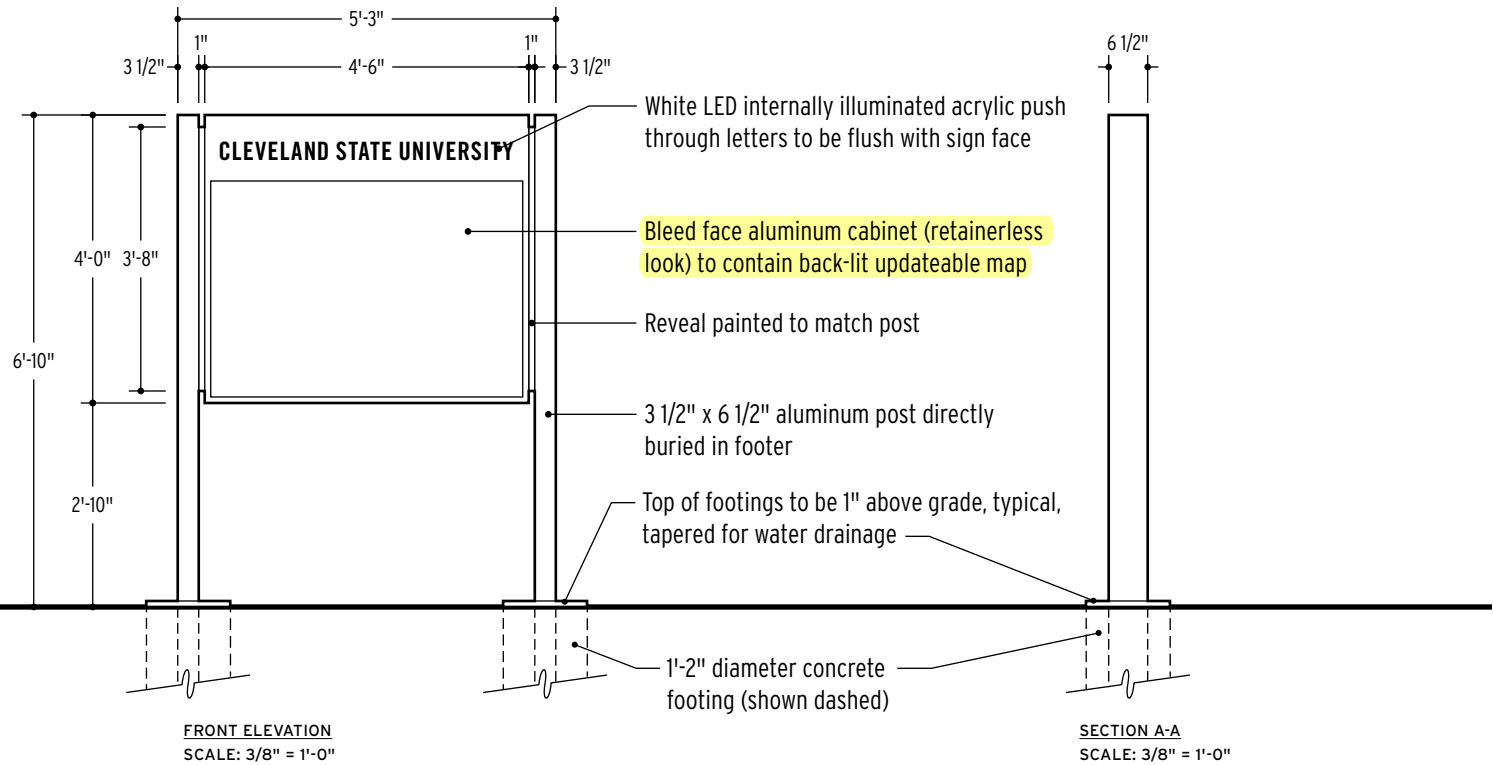
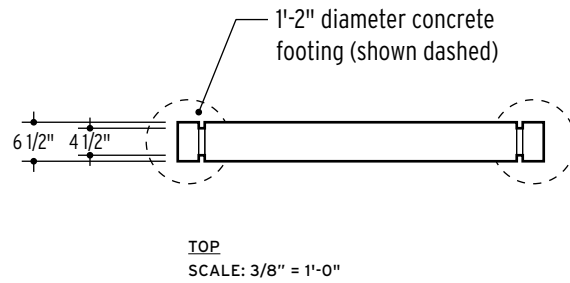

Exterior Sign Drawings
Identification

SECTION 3

B1 Primary Building ID Monument

Monument signs shall be continuously illuminated to aid in readability during daylight hours

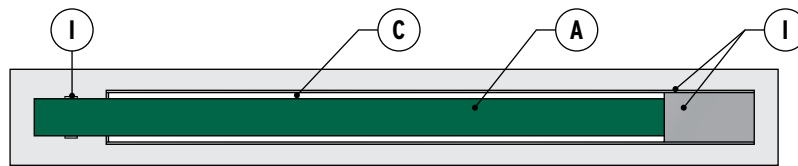

TOP
SCALE: 3/8" = 1'-0"

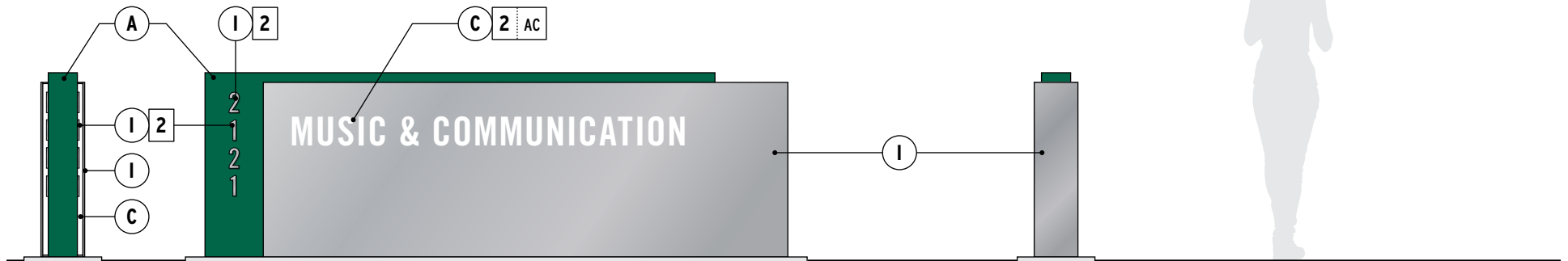

SIDE ELEVATION
SCALE: 3/8" = 1'-0"

FRONT ELEVATION
SCALE: 3/8" = 1'-0"

SIDE ELEVATION
SCALE: 3/8" = 1'-0"

SECTION 3

B1 Primary Building ID Monument

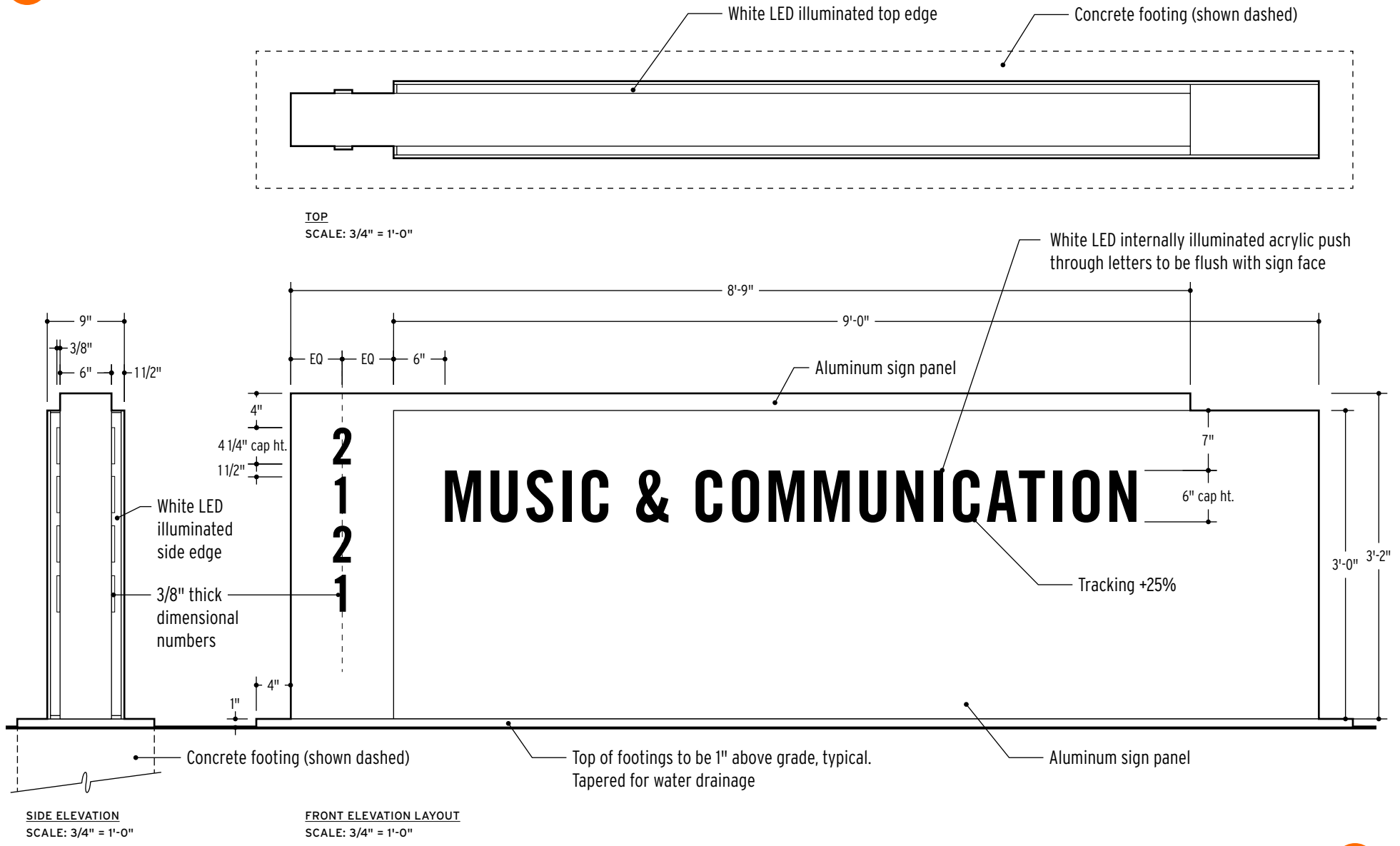

SIDE ELEVATION
SCALE: 3/4" = 1'-0"

FRONT ELEVATION LAYOUT
SCALE: 3/4" = 1'-0"

SECTION 3

B1 Primary Building ID Monument
Alternate

Sign height can be increased to accommodate longer messages. Use the below example as a base for non-typical messages.
Note: All dimensions the same unless otherwise noted.



ALT FRONT ELEVATION
SCALE: 3/4" = 1'-0"

SECTION 3

B2 Secondary Building ID
Freestanding

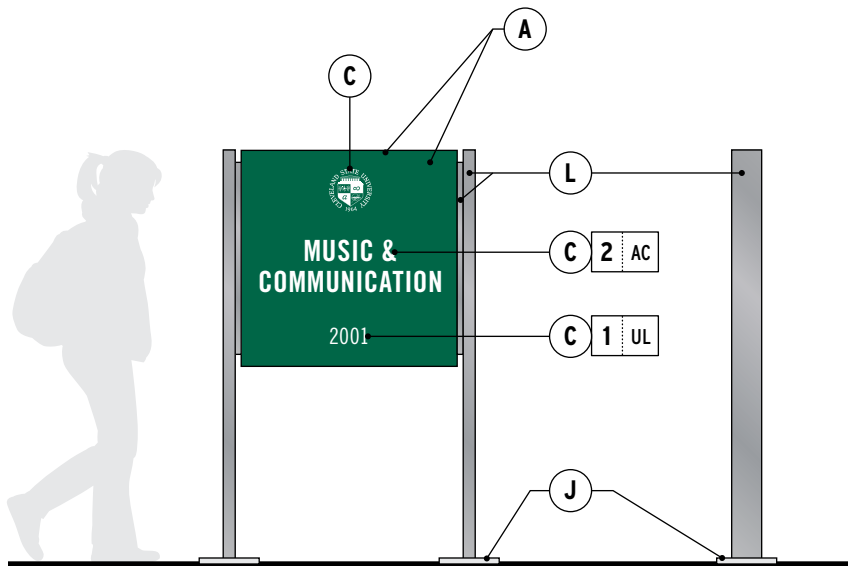

FRONT ELEVATION
SCALE: 3/8" = 1'

SIDE ELEVATION
SCALE: 3/8" = 1'

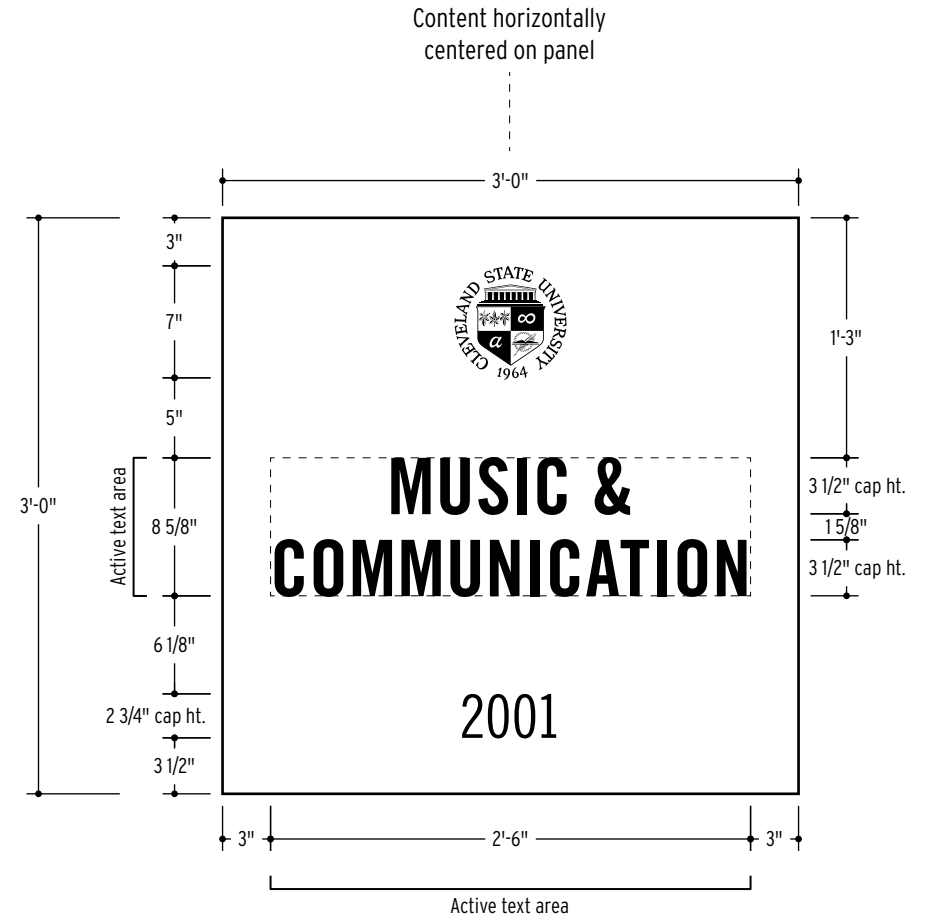

FRONT ELEVATION LAYOUT
SCALE: 1" = 1'

SECTION 3

B2 Secondary Building ID
Freestanding

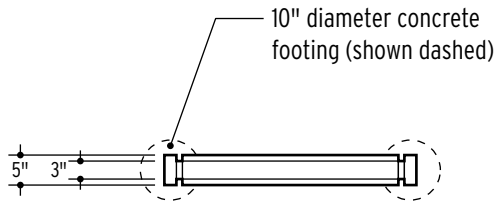

TOP
SCALE: 3/8" = 1'-0"

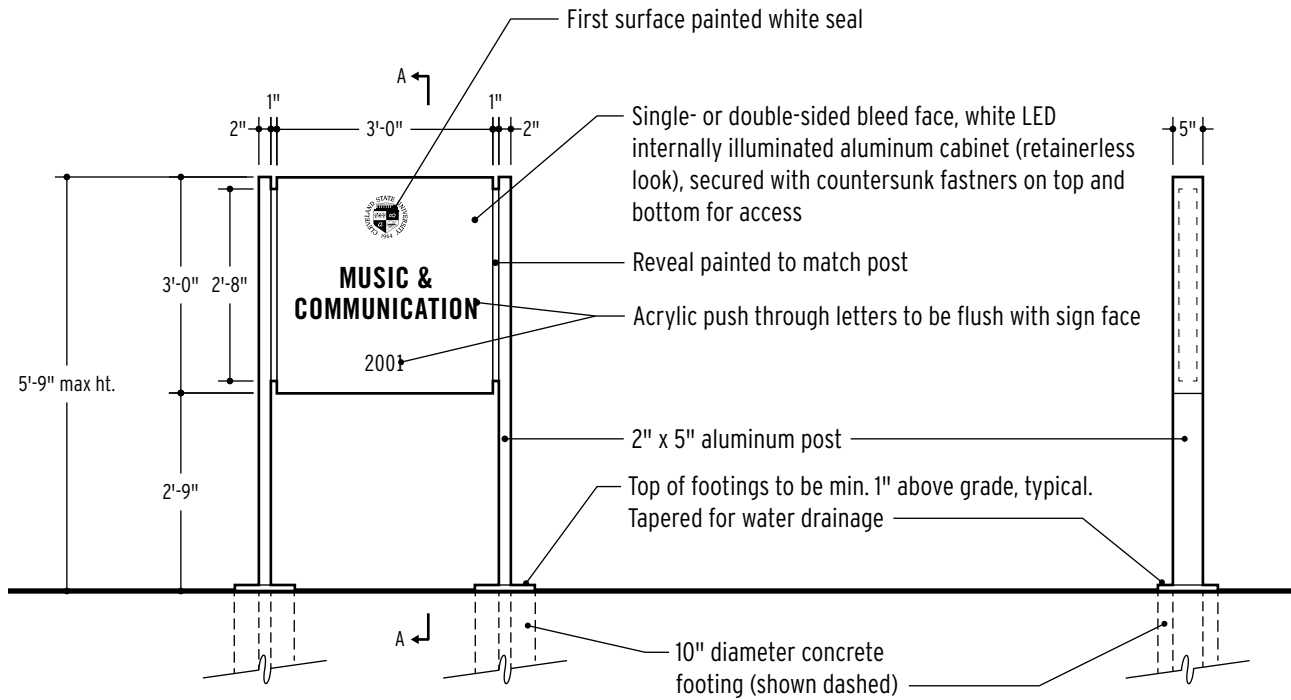

FRONT ELEVATION
SCALE: 3/8" = 1'

SECTION A-A
SCALE: 3/8" = 1'

Sign height can be increased to accommodate longer messages. Use the below example as a base for non-typical messages.

Note: All dimensions the same unless otherwise noted.

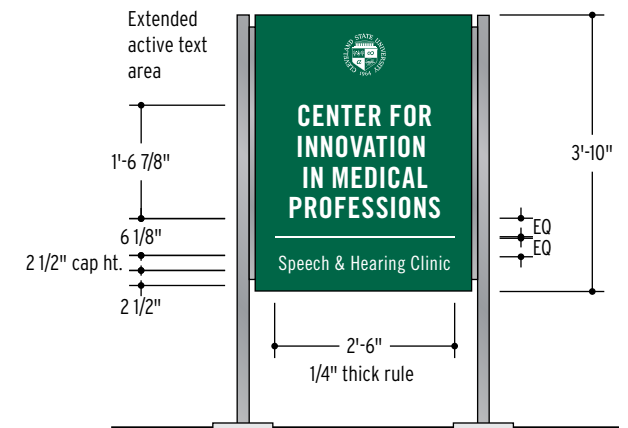
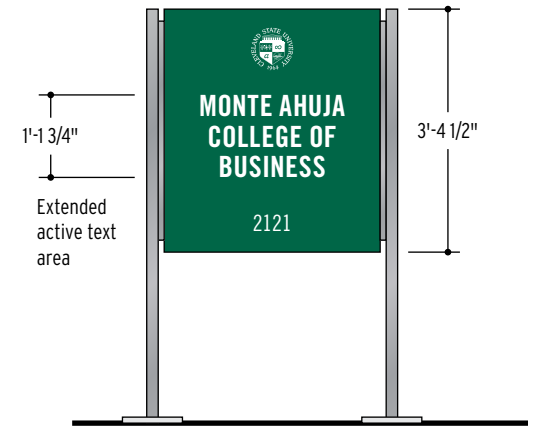

ALT FRONT ELEVATION
SCALE: 3/8" = 1'

SECTION 3

B2.1 Secondary Building ID
Wall-Mounted

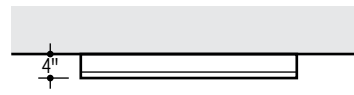

TOP
SCALE: 3/8" = 1'-0"



FRONT ELEVATION
SCALE: 3/8" = 1'

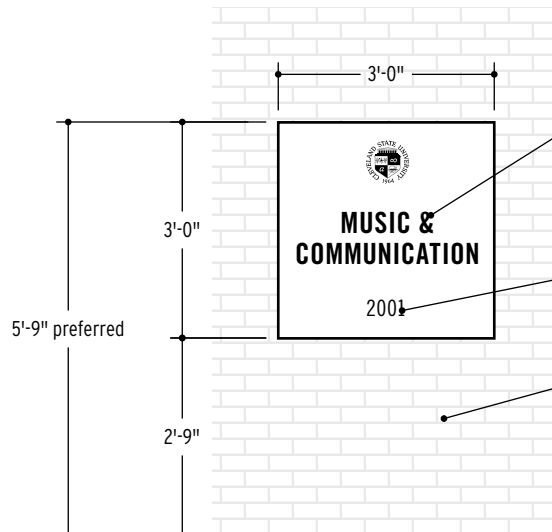

TYPICAL ELEVATION (CONDITIONS WILL VARY)
SCALE: 3/8" = 1'

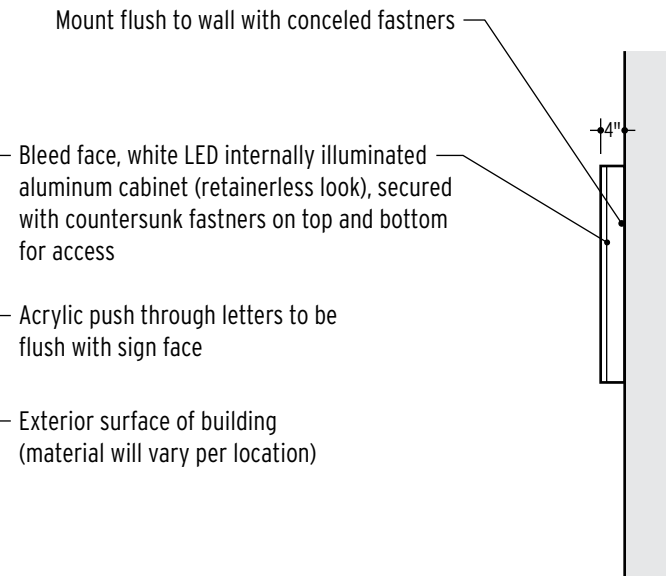

SIDE ELEVATION
SCALE: 3/8" = 1'

SECTION 3

B3 Building ID Dimensional Letters

Interior donor recognition shall also be dimensional letters - typically 3/8" thk. x 6-9" H depending on ceiling height

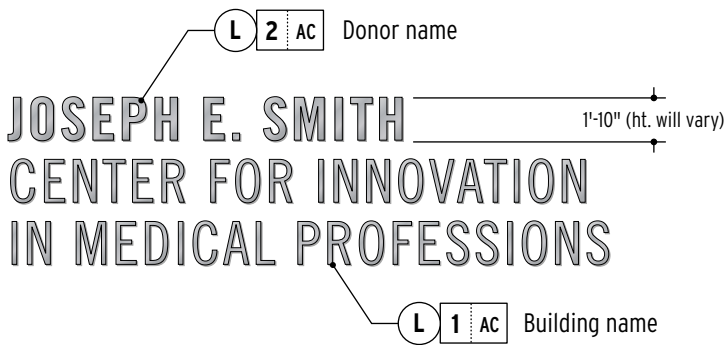

PREFERRED DIMENSIONAL LETTERS
SCALE: 1/8" = 1'

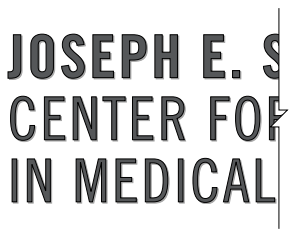

F Alternate Color
Dark Gray letters may be used only if the silver does not provide enough contrast with the background.

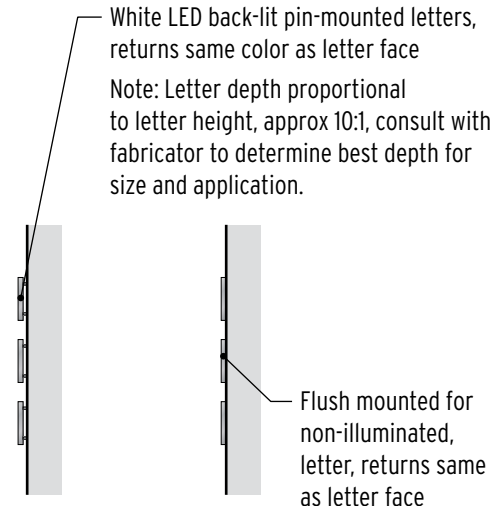

TYP. SECTION
SCALE: 1/8" = 1'

ALT. SECTION
SCALE: 1/8" = 1'

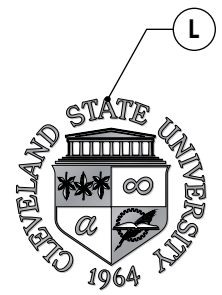

PREFERRED SEAL
SCALE: 1/8" = 1'

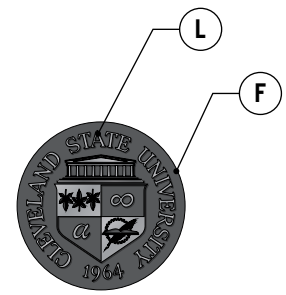

ALT. OPTION
SCALE: 1/8" = 1'

Individual letters and graphics is the preferred design. If size becomes too small to allow for individual elements, use the alternate option. Fabrication capabilities vary per contractor-consult sign contractor.
Notes: The seal with a back-lit is acceptable but not recommended (varies per project).
For alternate option, use the reversed seal (page 3) when mounting to buildings).

Note: All dimensional letters and optional elements are considered custom and are to be approved by OUA prior to fabrication. Signs shown here are examples of typical design and material options for custom identification.

SECTION 3

B4 Vinyl - Exterior Building ID + Interior Department ID

When there are more than 2 doors, mirror arrangement as shown below.

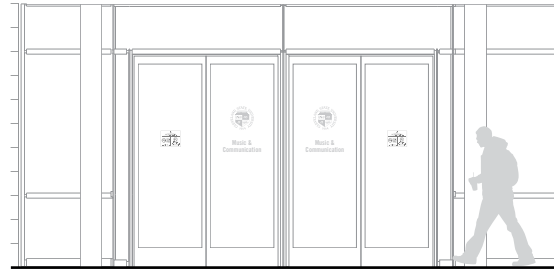

ALT ELEVATION
SCALE: 1/8" = 1'



**Dept. of
Africana Studies**

DEPARTMENT ID DECAL
typically frosted film on glass

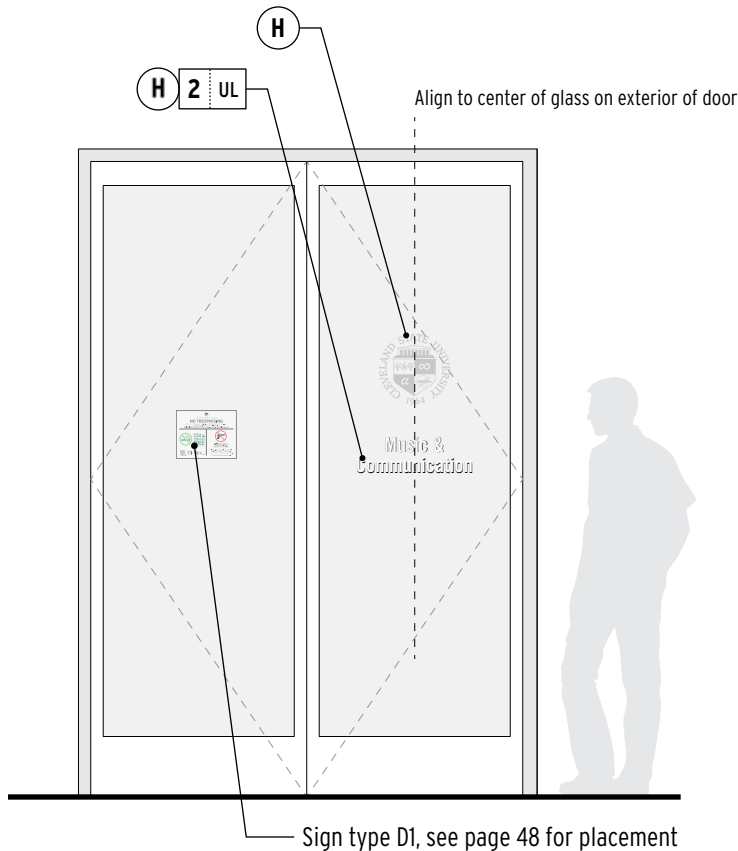

FRONT ELEVATION
SCALE: 3/8" = 1'

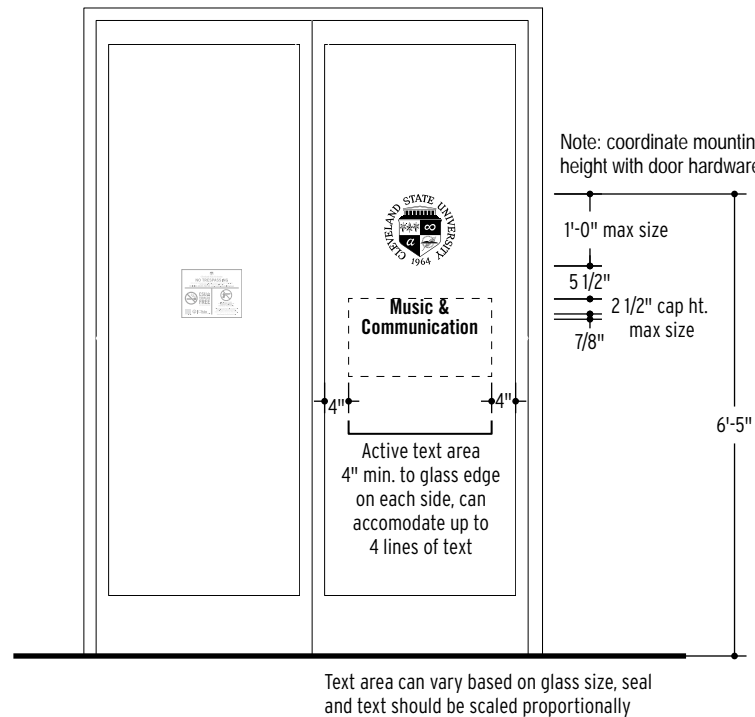

TYPICAL ELEVATION (CONDITIONS WILL VARY)
SCALE: 3/8" = 1'

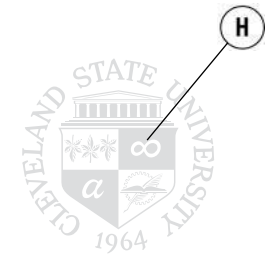

**Music &
Communication**

H 2 UL

BUILDING ID DECAL
typically frosted film on glass
SCALE: 1" = 1'

SECTION 3

B5 Parking Structure / Lot ID
Freestanding

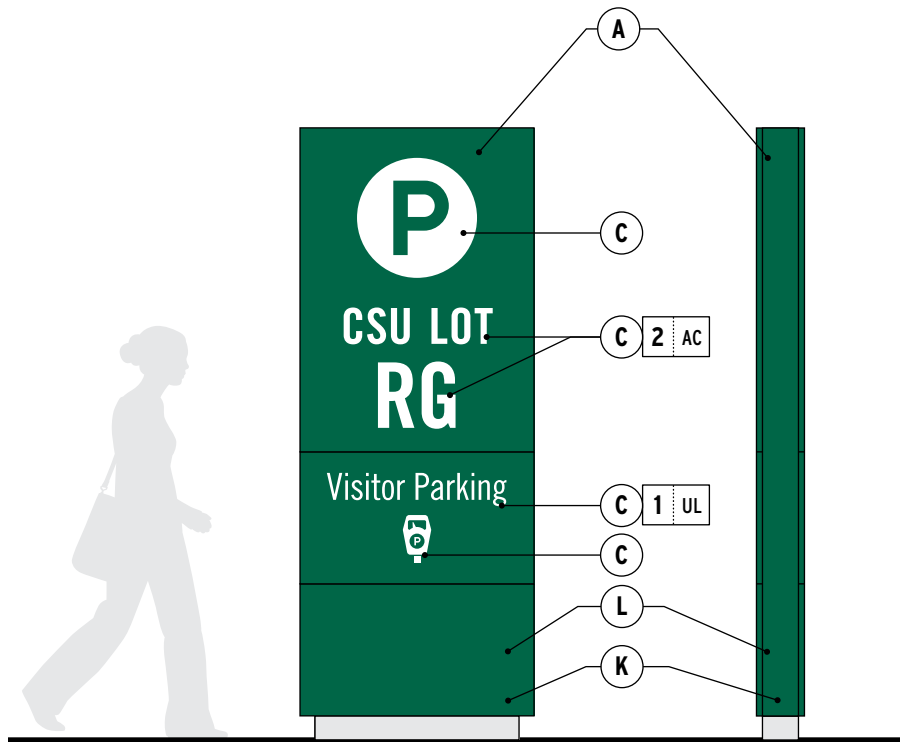

FRONT ELEVATION
SCALE: 3/8" = 1'

SIDE ELEVATION
SCALE: 3/8" = 1'

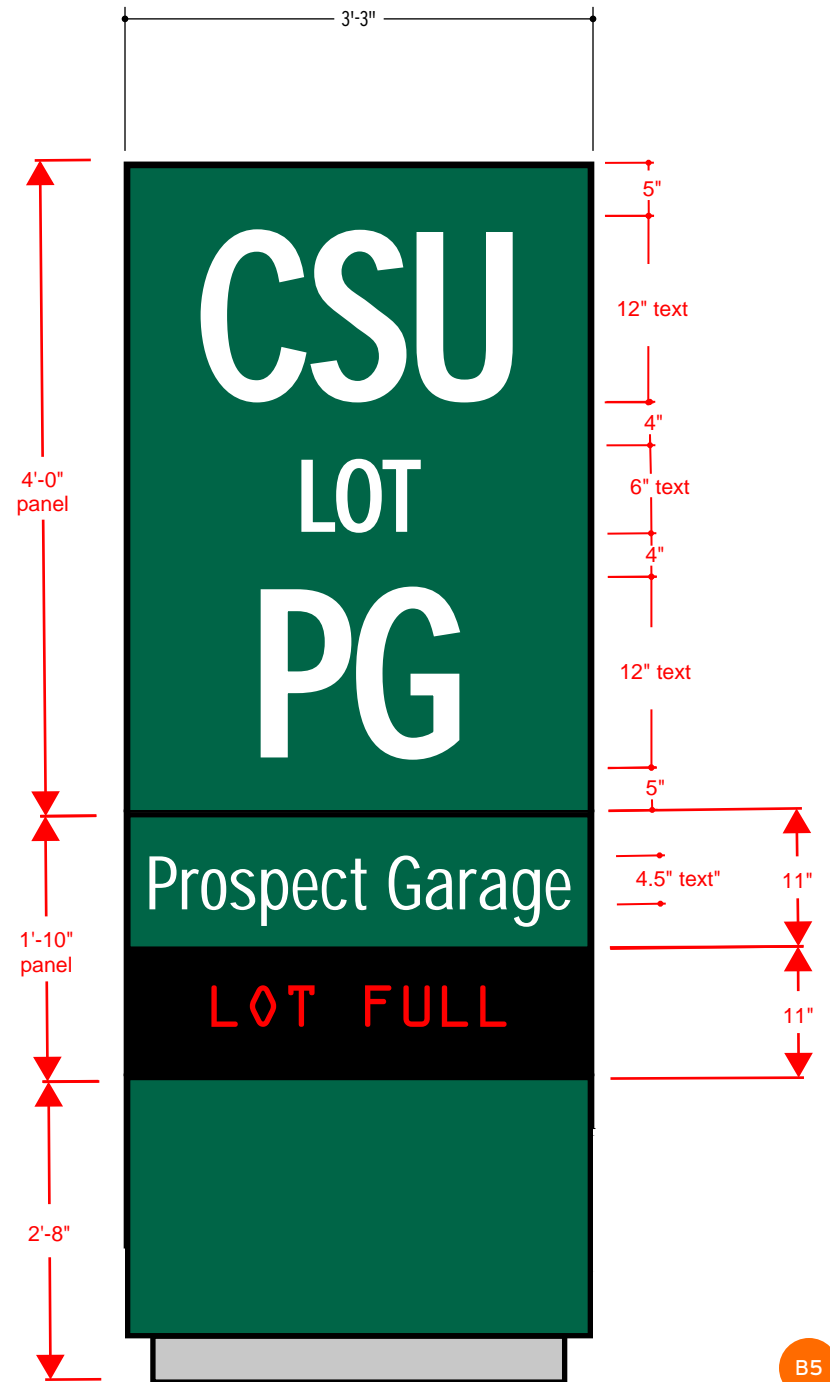

SECTION 3

B5 Parking Structure / Lot ID
Freestanding

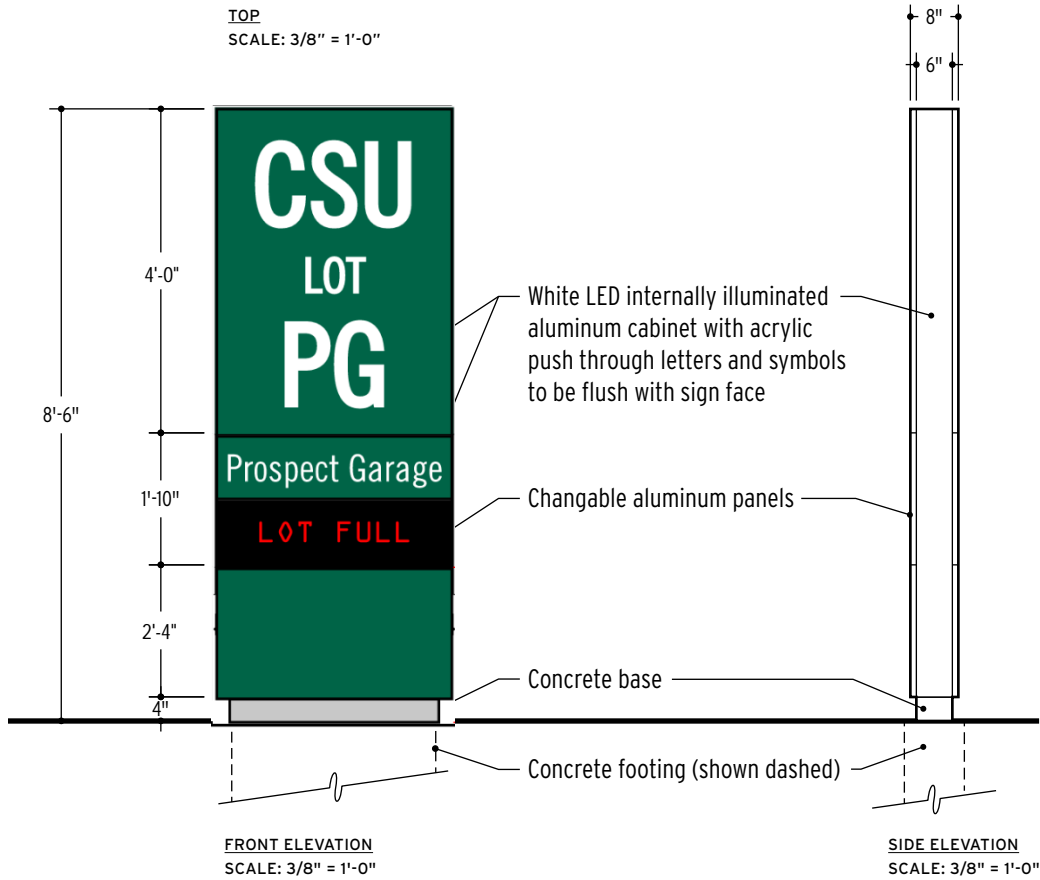
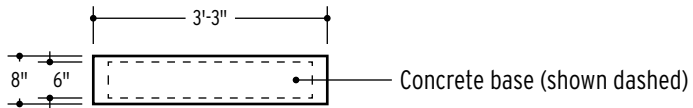

SECTION 3

B5.1 Parking Structure / Lot ID
Flag-Mounted

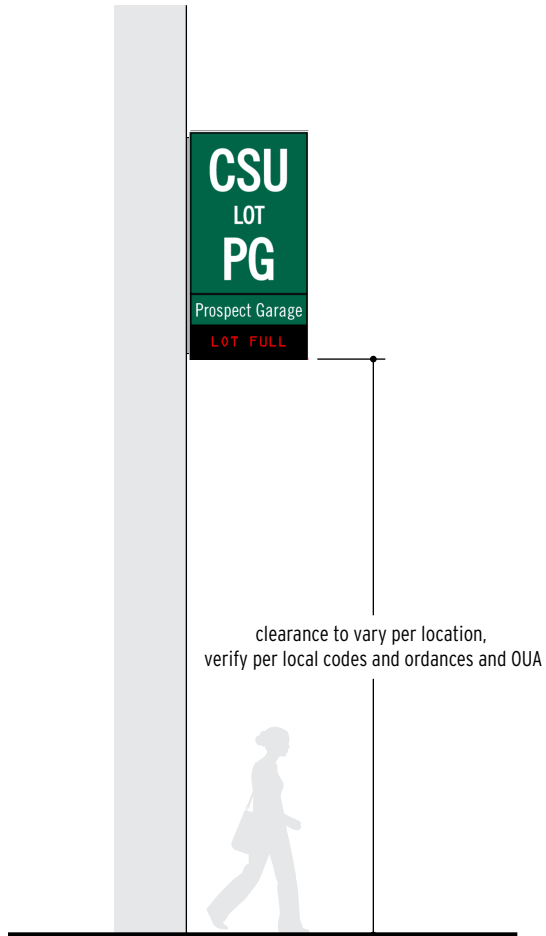

FRONT ELEVATION
SCALE: 3/8" = 1'-0"

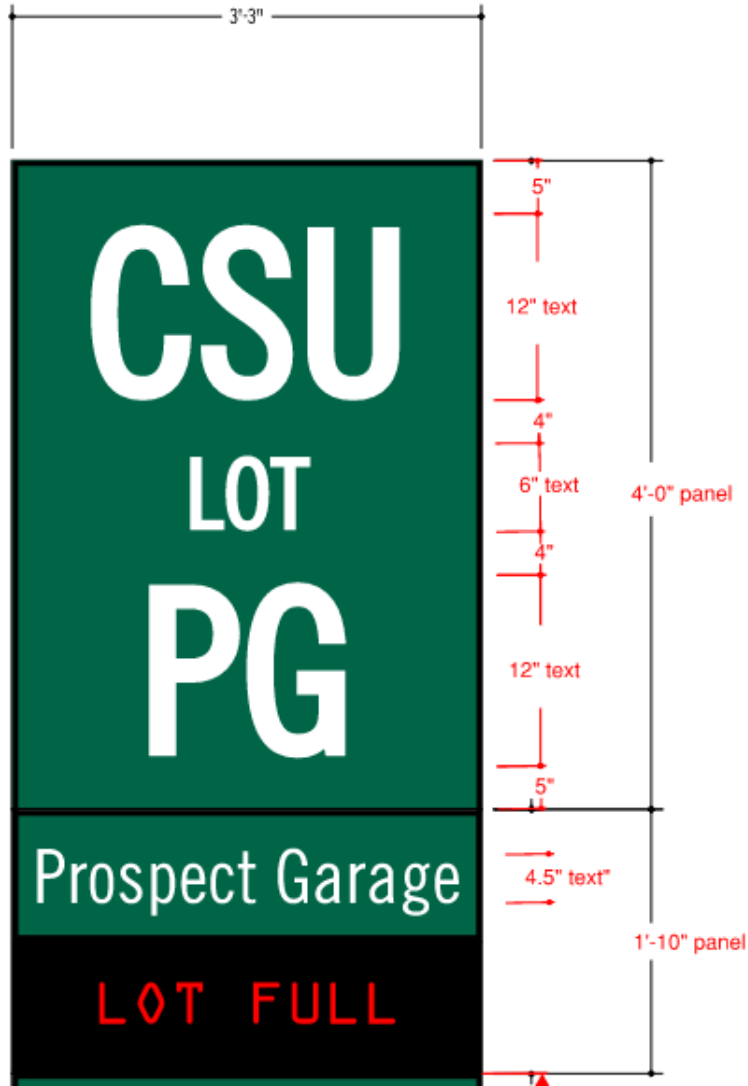

FRONT ELEVATION

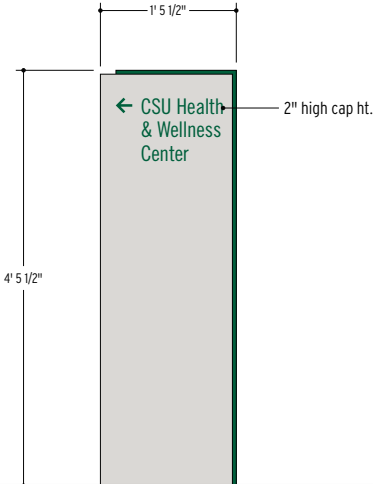

**XX - PEDESTRIAN DIRECTIONAL
FRONT ELEVATION**
SCALE: 3/4"=1'

SECTION 3

Exterior Sign Drawings
Regulatory

SECTION 3

C1 Regulatory Signs
Post

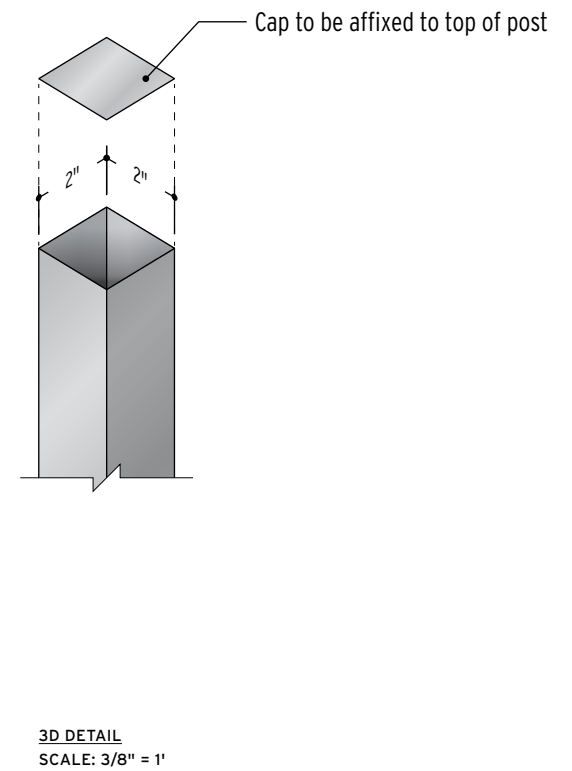
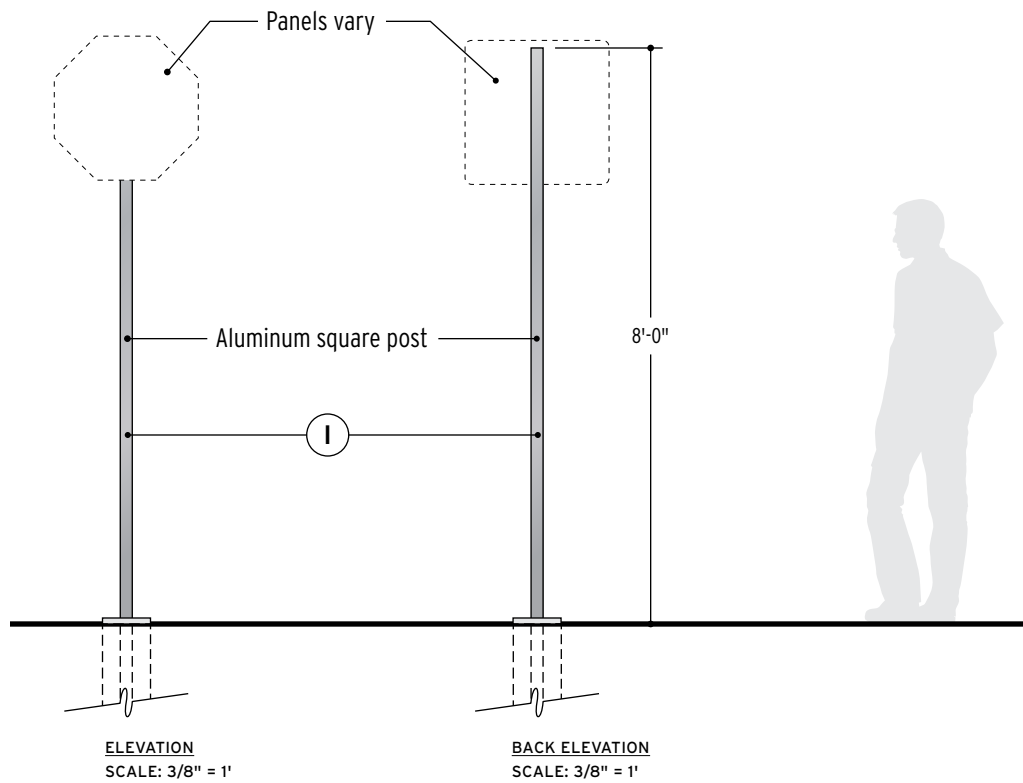

SECTION 3

Exterior Sign Drawings

Speciality / LEED®

SECTION 3

D1 No Trespassing, Smoking, Firearms

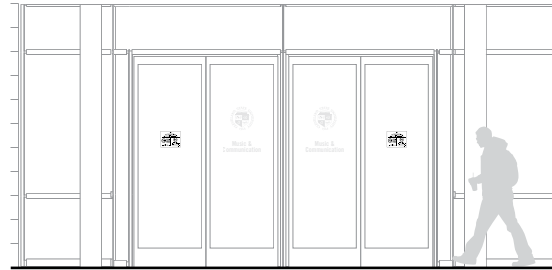

When there are more than 2 doors, mirror the arrangement, see drawing to the left.

ALT ELEVATION
SCALE: 1/8" = 1'

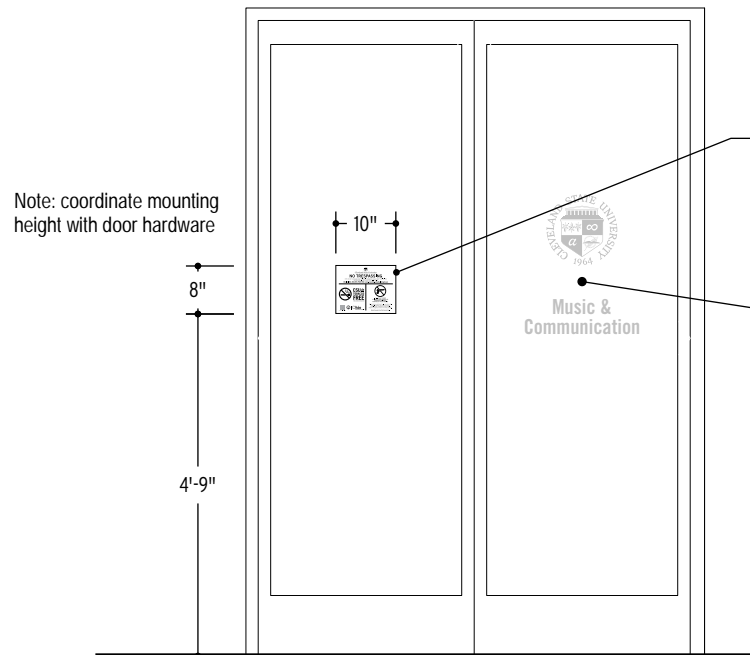

Note: coordinate mounting height with door hardware

Standard CSU No Trespassing, Smoking, Firearms vinyl decal - centered vertically on glass on LEFT door

Sign type B4 on RIGHT door (see p.42 for placement)

installed at EXTERIOR vestibule doors

TYPICAL ELEVATION (CONDITIONS WILL VARY)
SCALE: 3/8" = 1'



Artwork provided by CSU - to be printed on white background

DETAIL
SCALE: 1 1/2" = 1'

SECTION 3

D2 Welcome



Artwork provided by CSU - to be printed on clear background

DETAIL
SCALE: 1" = 1'

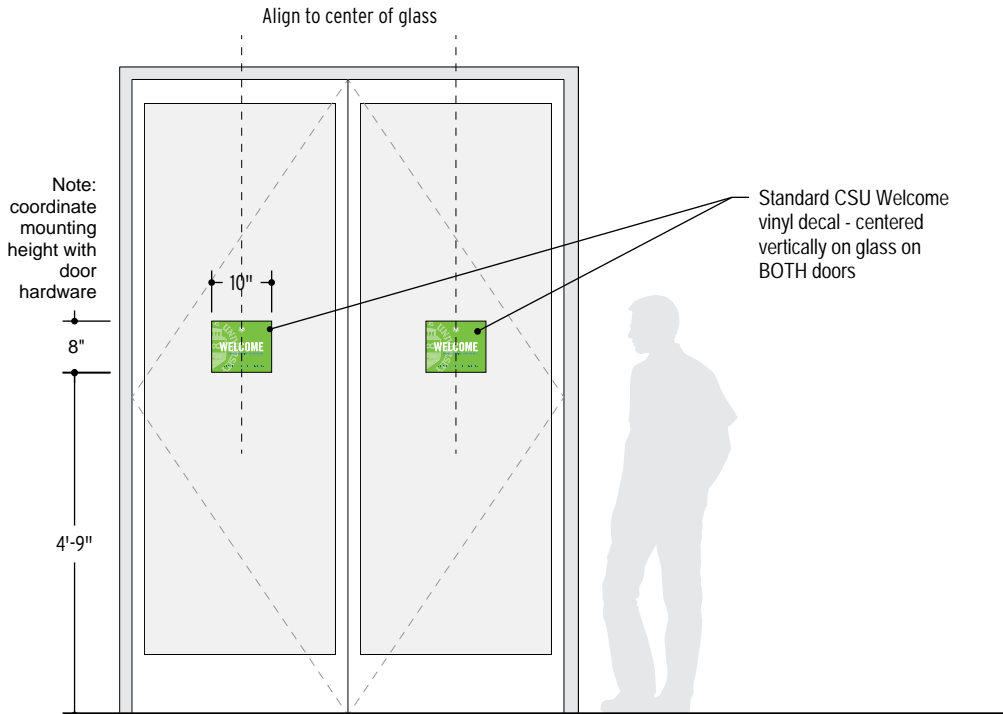

installed at INTERIOR vestibule doors

TYPICAL ELEVATION (CONDITIONS WILL VARY)
SCALE: 3/8" = 1'

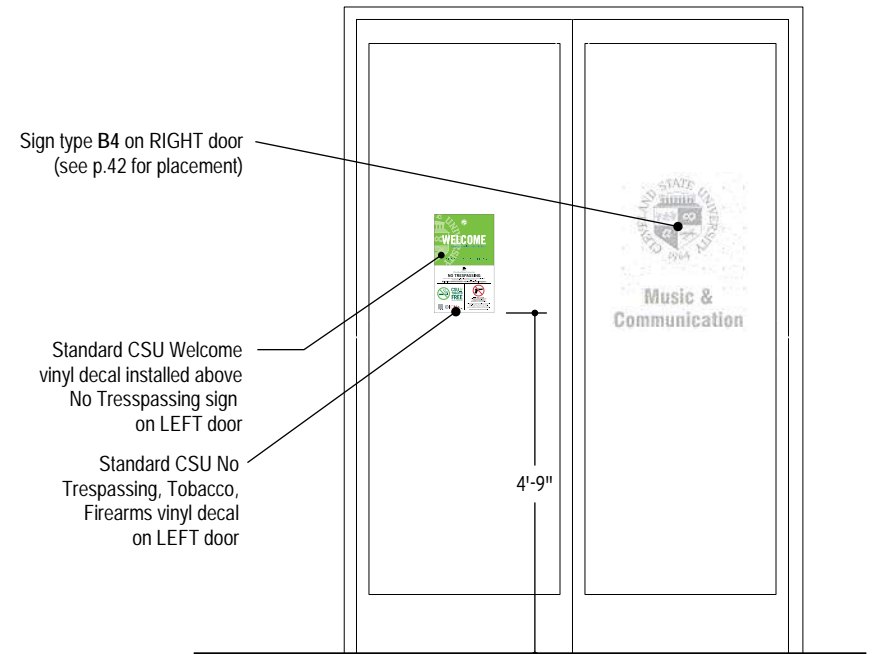

if no vestibule, Welcome sign to be installed above No Trespassing sign

ALT ELEVATION
SCALE: 3/8" = 1'

SECTION 3

D3 No Smoking
Pole-Mounted

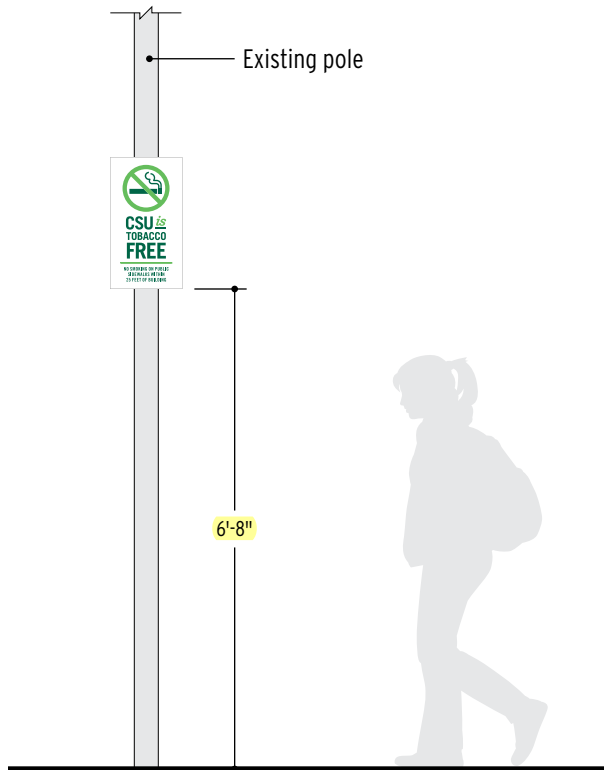

ELEVATION
SCALE: 3/8" = 1'

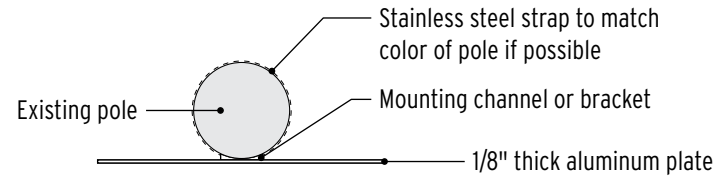

TOP
SCALE: 1 1/2" = 1'

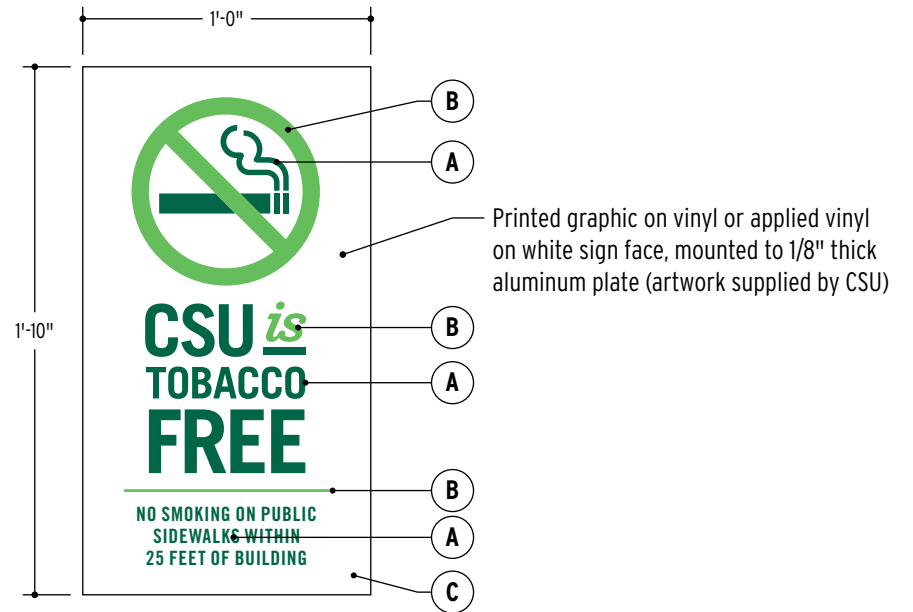

DETAIL
SCALE: 1 1/2" = 1'

SECTION 3

D3.1 No Smoking
Post-Mounted

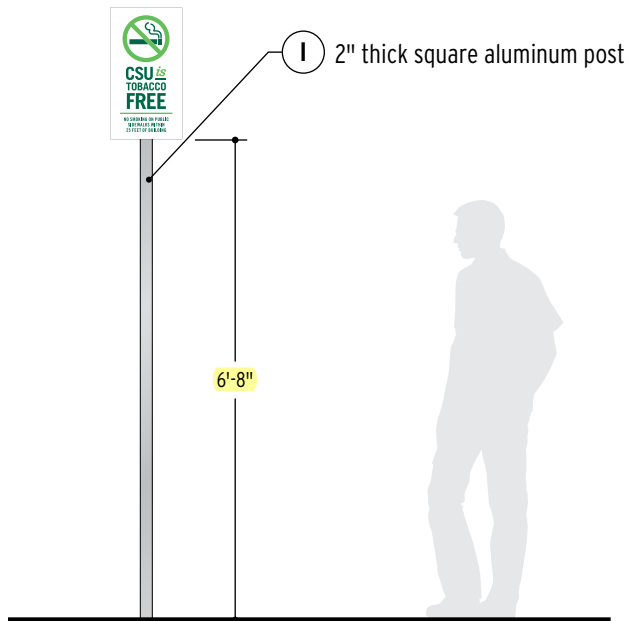

ELEVATION
SCALE: 3/8" = 1'

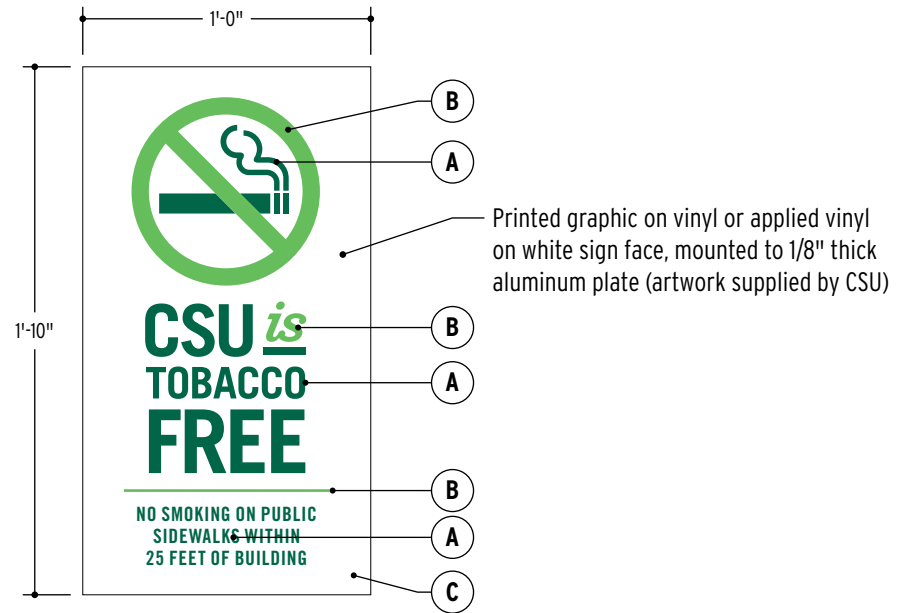

DETAIL
SCALE: 1 1/2" = 1'

● Interior Sign Drawings

Orientation / Information

Directional

Identification

Regulatory

● Donor Recognition

SECTION 4

Interior Sign Drawings

Orientation / Information

SECTION 4

E1 Electronic Information Kiosk
Freestanding

Discuss use with IS&T and building SACC as electronic directories have not been maintained in most buildings

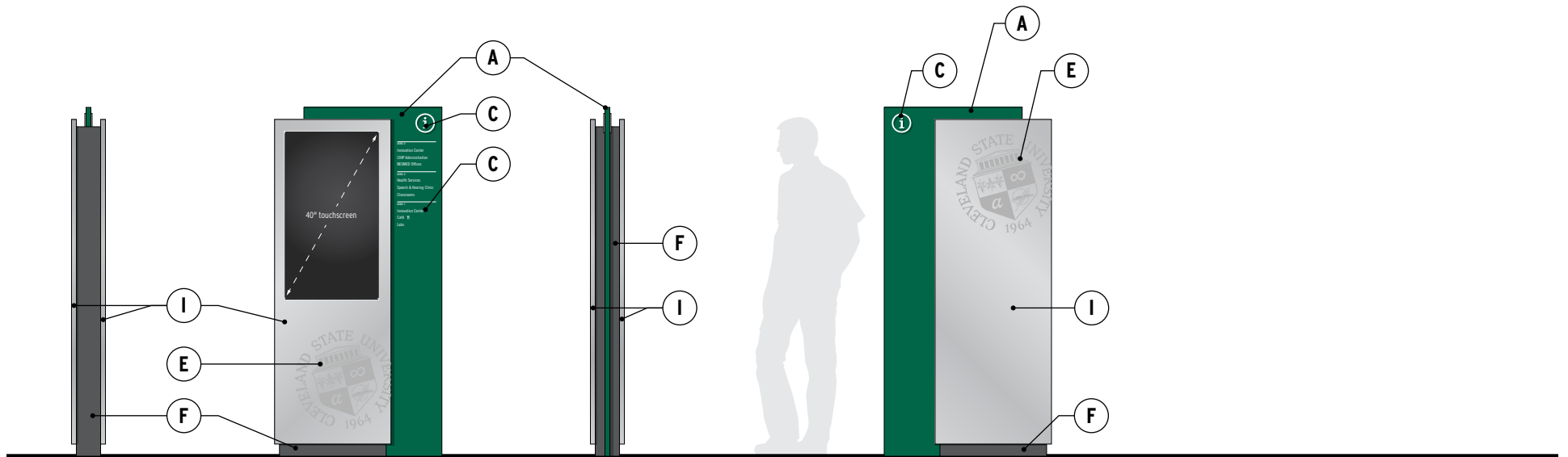

SIDE ELEVATION
SCALE: 3/8" = 1'-0"

FRONT ELEVATION
SCALE: 3/8" = 1'-0"

SIDE ELEVATION
SCALE: 3/8" = 1'-0"

BACK ELEVATION
SCALE: 3/8" = 1'-0"

SECTION 4

E1 Electronic Information Kiosk
Freestanding

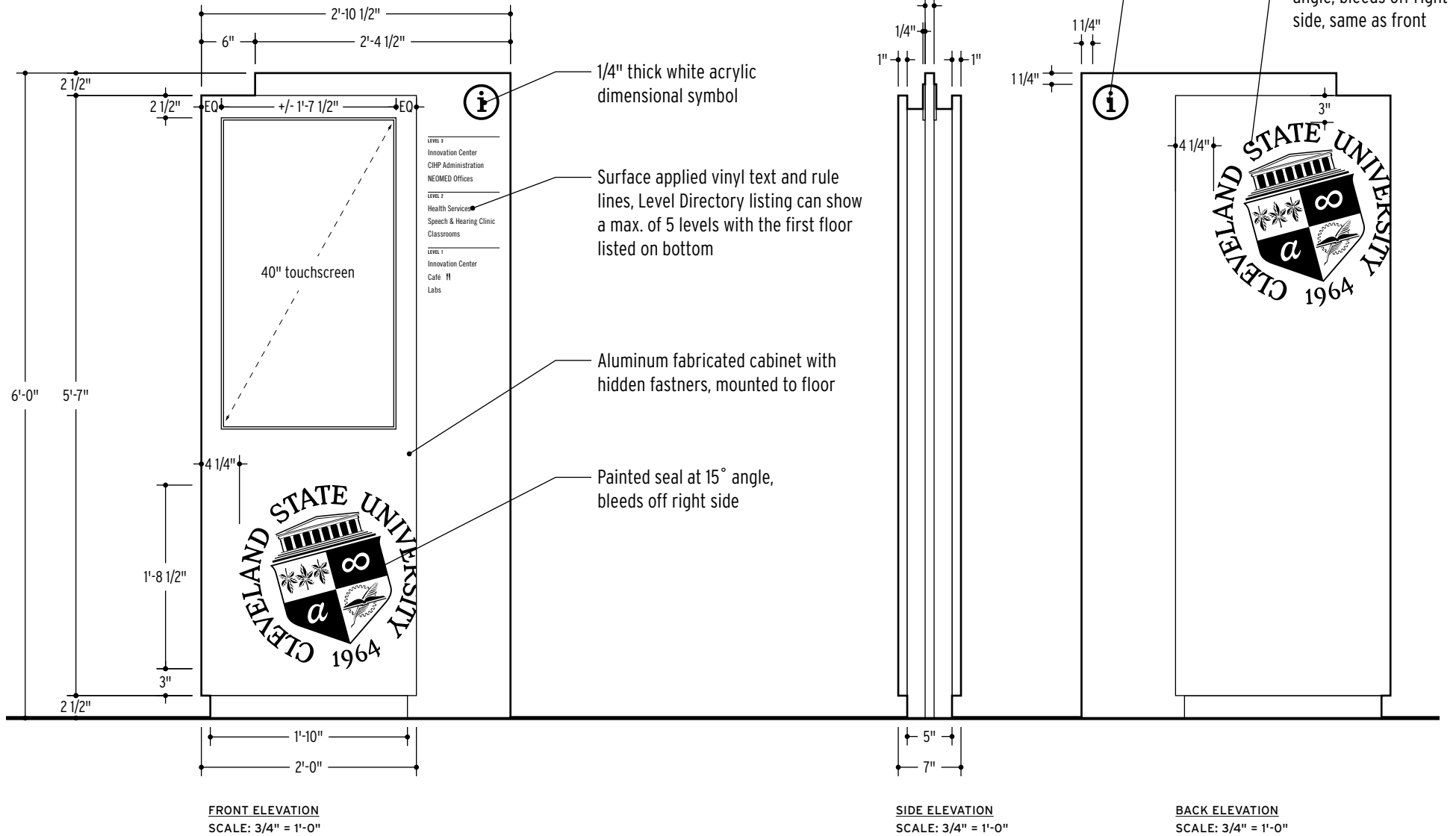

SECTION 4

E1 Electronic Information Kiosk
Freestanding

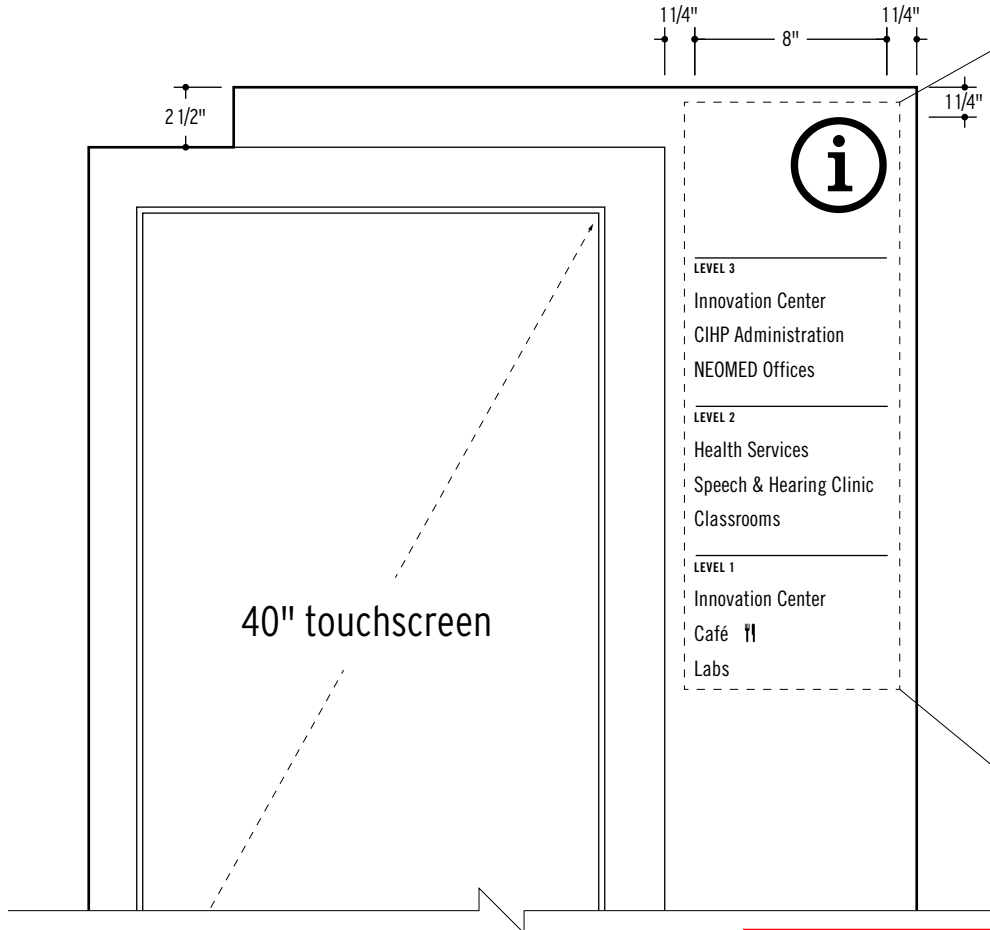

Limit verbiage to generic department names (which can change) and destinations not likely to be renamed or relocated (e.g. Auditorium, Health & Wellness Clinic)

FRONT ELEVATION LAYOUT
SCALE: 1 1/2" = 1'-0"

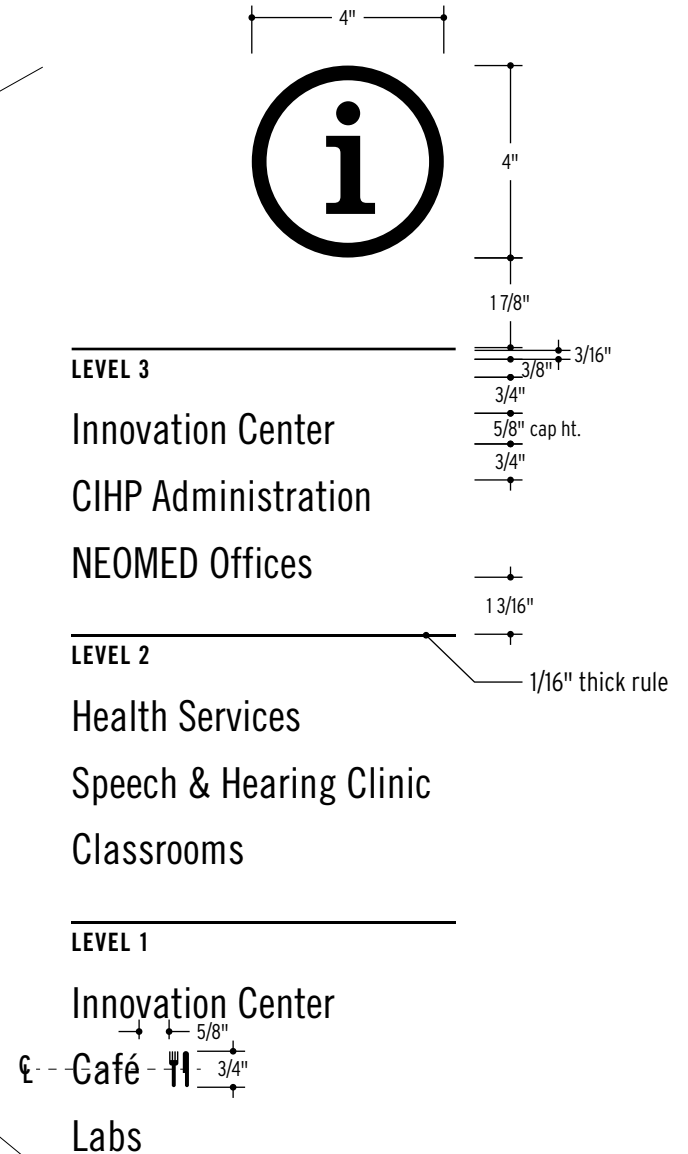

APPLIED TEXT DETAIL
SCALE: 3" = 1'-0"

SECTION 4

E1.1 Electronic Information Kiosk
Wall-Mounted

Discuss use with IS&T and building SACC as electronic directories have not been maintained in most buildings

Note: All dimensions the same as freestanding unless otherwise noted. See sign type E1.

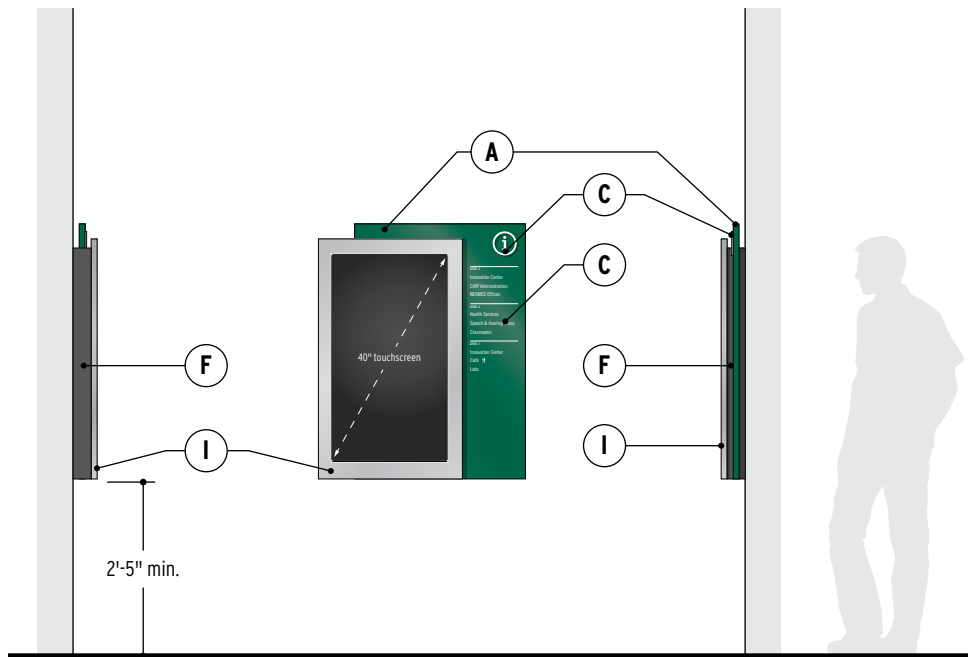

SIDE ELEVATION
SCALE: 3/8" = 1'-0"

FRONT ELEVATION
SCALE: 3/8" = 1'-0"

SIDE ELEVATION
SCALE: 3/8" = 1'-0"

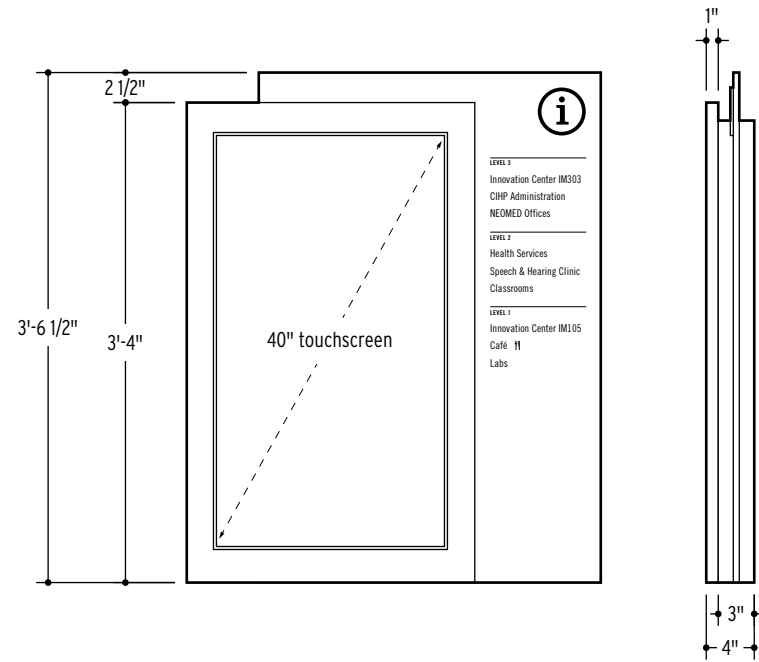

FRONT ELEVATION
SCALE: 3/4" = 1'-0"

SECTION 4

E2 Level Directory
Wall-Mounted

Metal JRS frames are no longer available.

Directory frames to be Takeform, 22"x22", top thumb notch, satin silver frame.

QR code inserts maintained by CSU Delta/Marketing and provided by Duplicating.

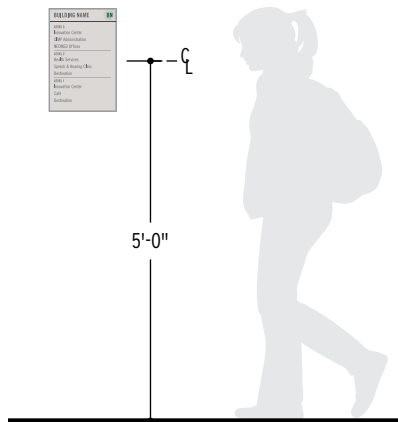

TYPICAL ELEVATION

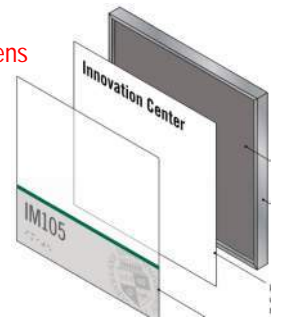
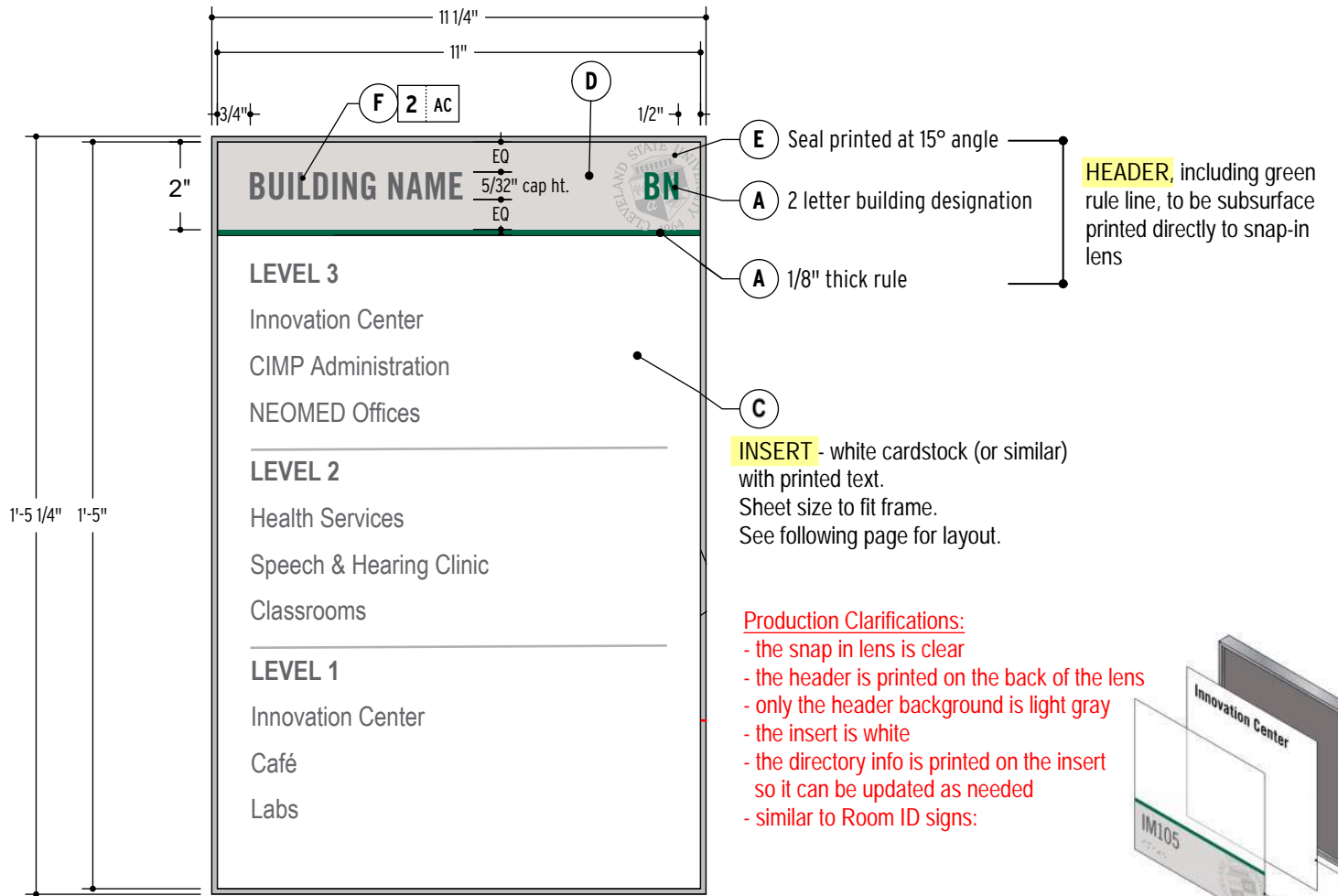

See p.83 for frame construction

DETAIL
SCALE: 3" = 1'

SECTION 4

E2 Level Directory
Wall-Mounted

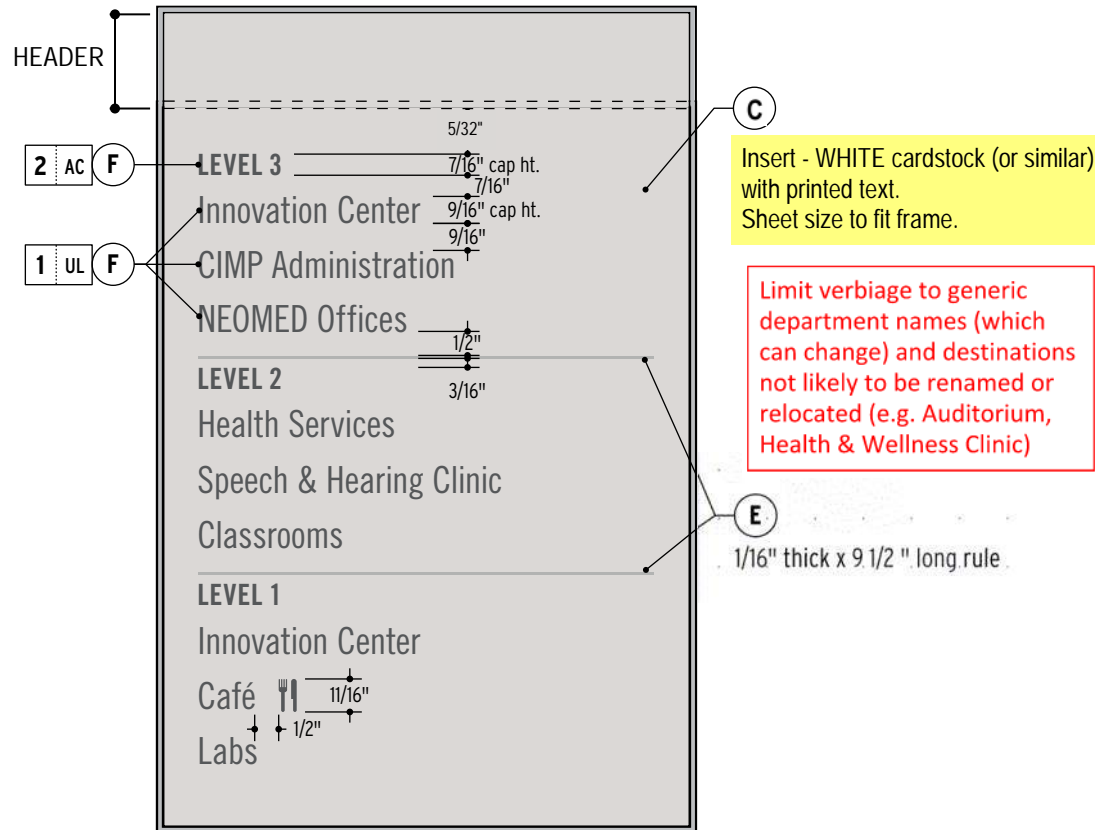

INSERT
DETAIL
SCALE: 3" = 1'

SECTION 4

Interior Sign Drawings
Directional

SECTION 4

F1 Wall Directional

Limit verbiage to generic department names (which can change) and destinations not likely to be renamed or relocated (e.g. Auditorium, Health & Wellness Clinic)

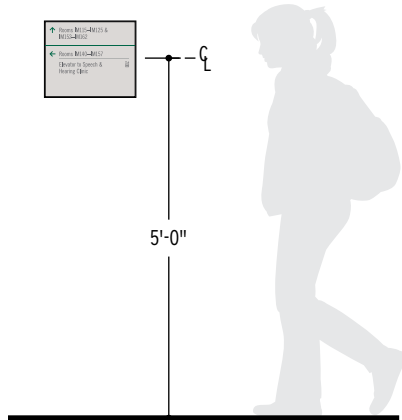

TYPICAL ELEVATION
SCALE: 3/8" = 1'



ALT DETAIL - SMALL = UP TO 4 LINES OF TEXT
SCALE: 1 1/2" = 1'

Sign width is the same as larger sign type.

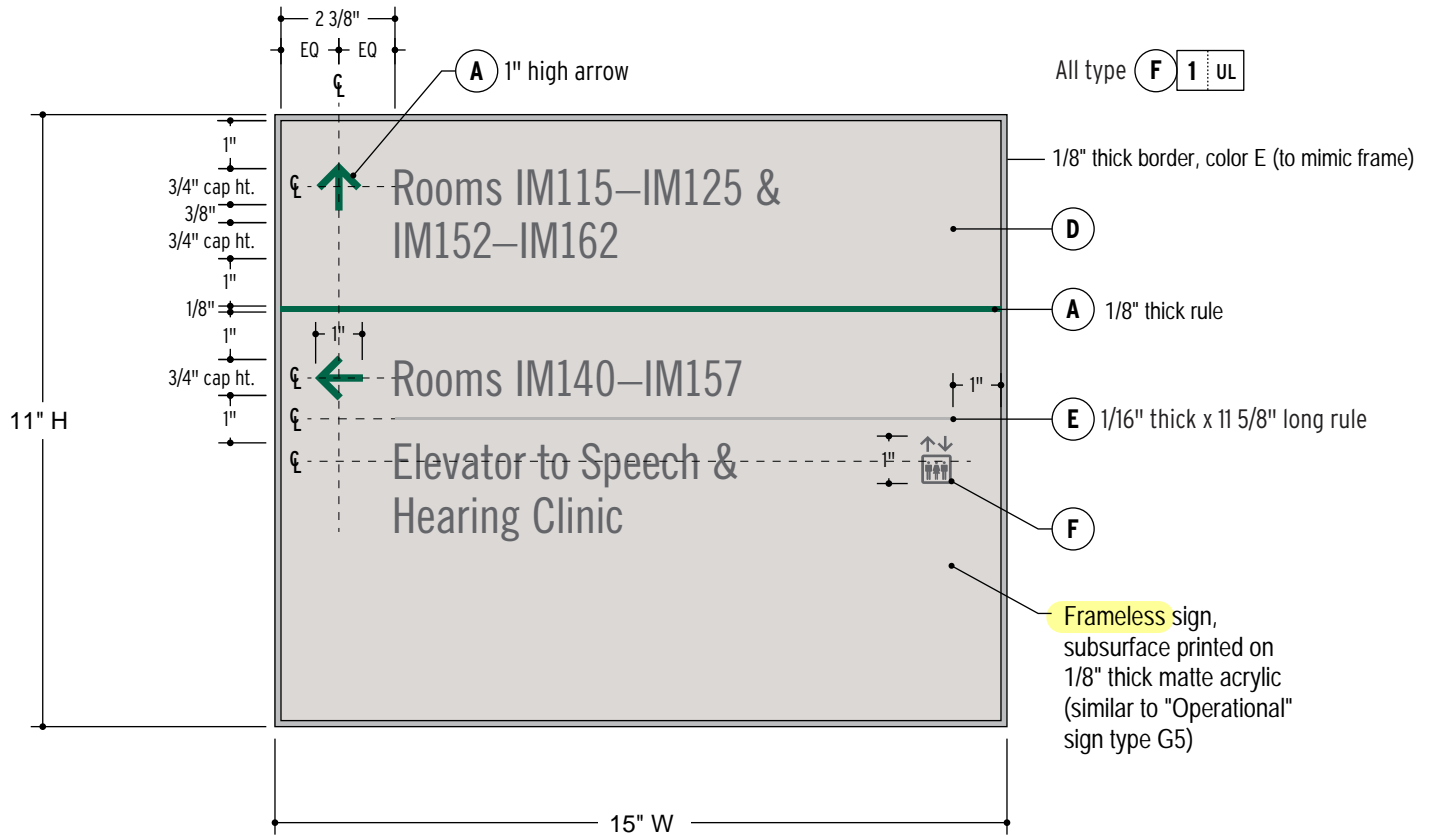

DETAIL - LARGE = 6-8 LINES OF TEXT
SCALE: 3" = 1'

All type (F) 1 UL

1/8" thick border, color E (to mimic frame)

(D)

(A) 1/8" thick rule

(E) 1/16" thick x 11 5/8" long rule

(F)

Frameless sign, subsurface printed on 1/8" thick matte acrylic (similar to "Operational" sign type G5)

SECTION 4

F1 Wall Directional
Special Conditions

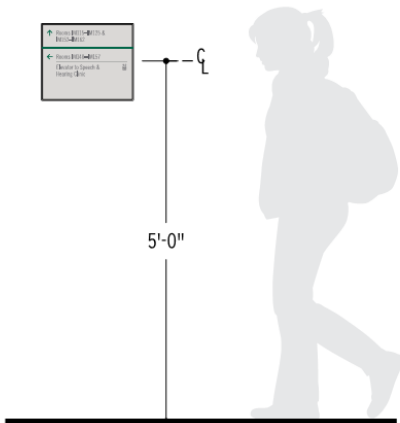

TYPICAL ELEVATION
SCALE: 3/8" = 1'

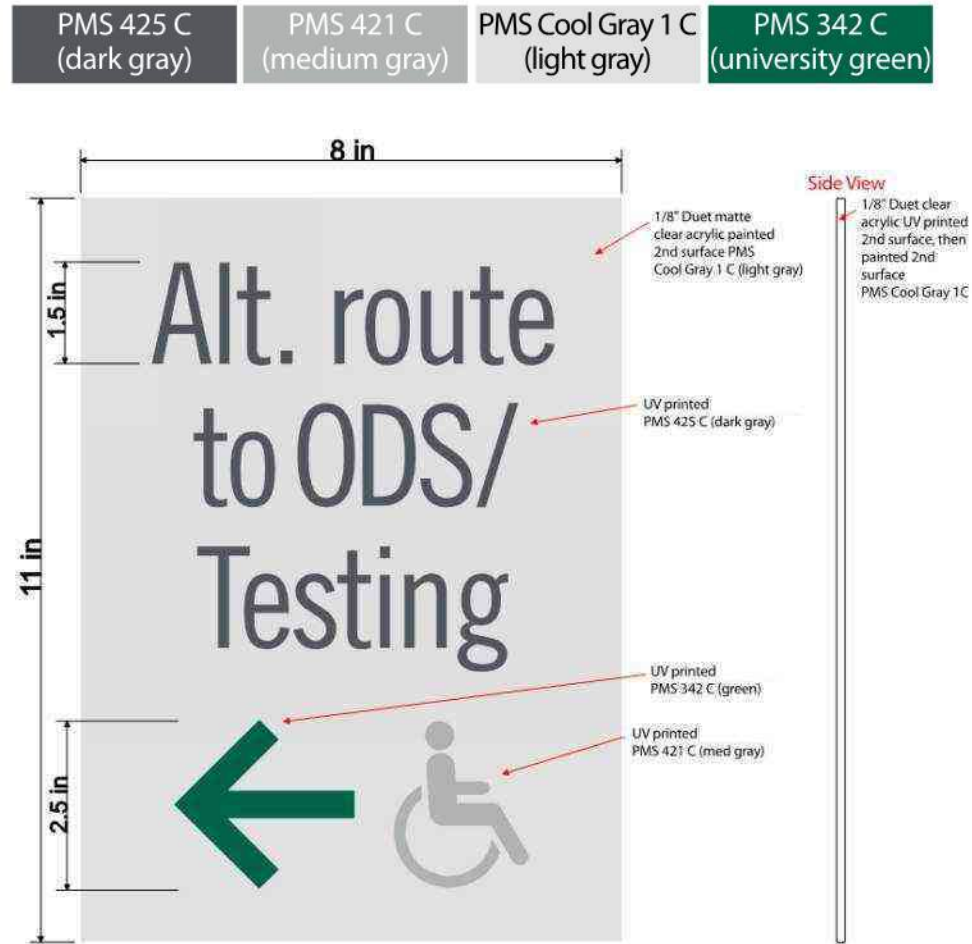

Frameless sign
8"W x 11"H max.
subsurface printed on
1/8" thick matte acrylic
(similar to "Operational"
sign type G5)

SECTION 4

F2 Overhead Directional Hanging

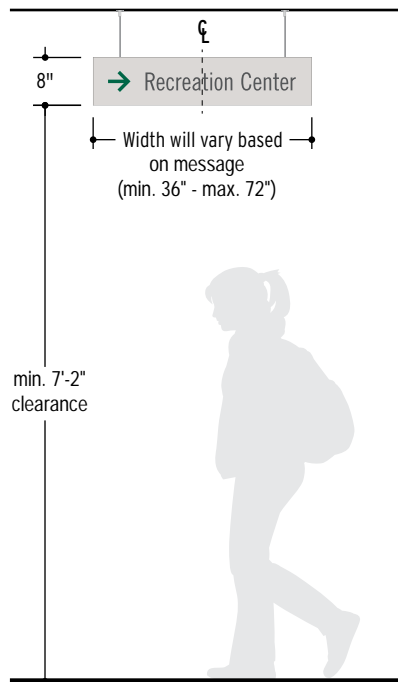

ELEVATION (CONDITIONS WILL VARY)
SCALE: 3/8" = 1'

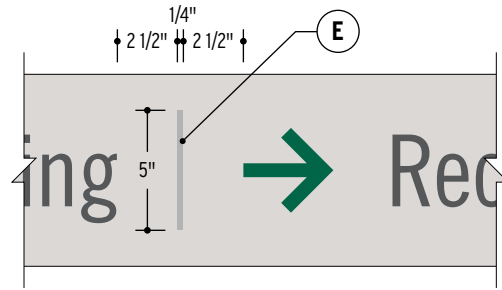

DETAIL (BETWEEN (2) MESSAGES)
SCALE: 3" = 1'

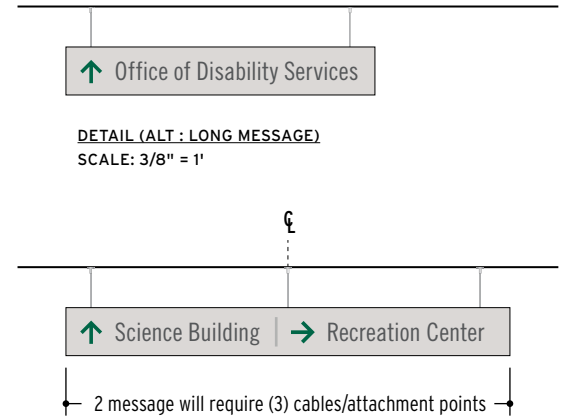

DETAIL (ALT : LONG MESSAGE)
SCALE: 3/8" = 1'

ELEVATION (ALT : (2) MESSAGES)
SCALE: 3/8" = 1'

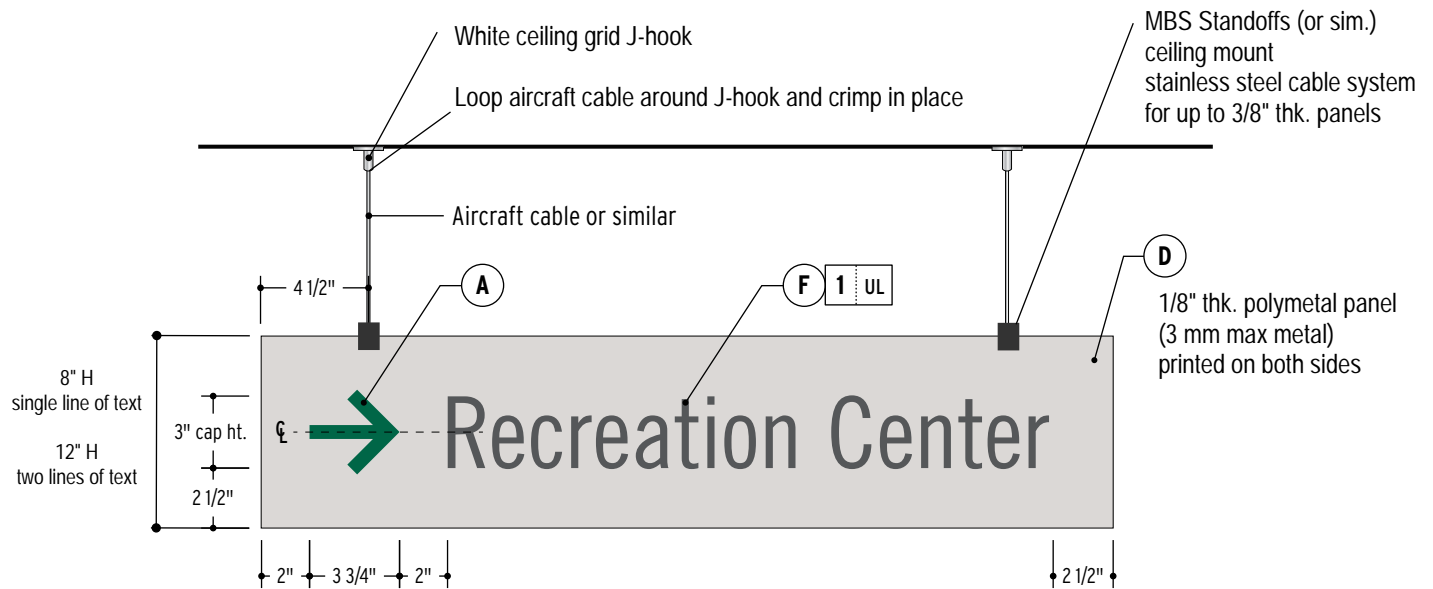

DETAIL
SCALE: 3" = 1'

SECTION 4

F2.1 Overhead Directional Ceiling-Mounted

Note: To be used as alternate to hanging overhead directional (see previous page) if not enough clearance between floor and ceiling. All dimensions and specs are the same unless otherwise noted (see previous page).

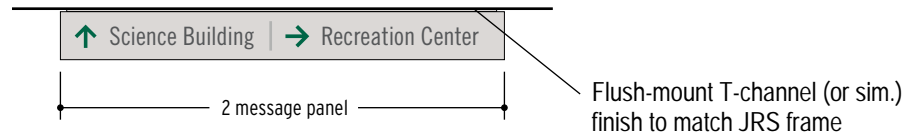
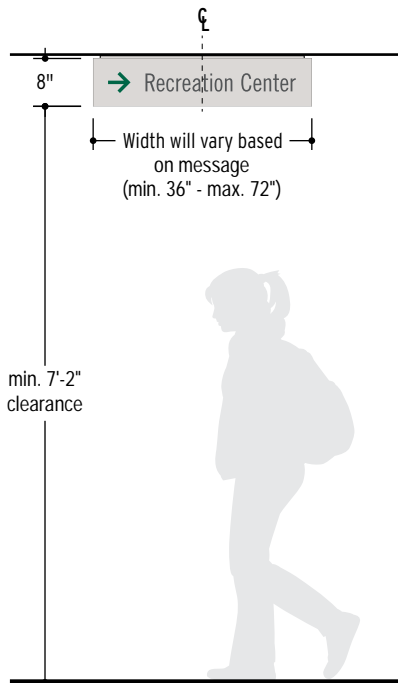

ELEVATION (ALT : (2) MESSAGES)
SCALE: 3/8" = 1'

ELEVATION (CONDITIONS WILL VARY)
SCALE: 3/8" = 1'

SECTION 4

F3 Free-Standing Directional

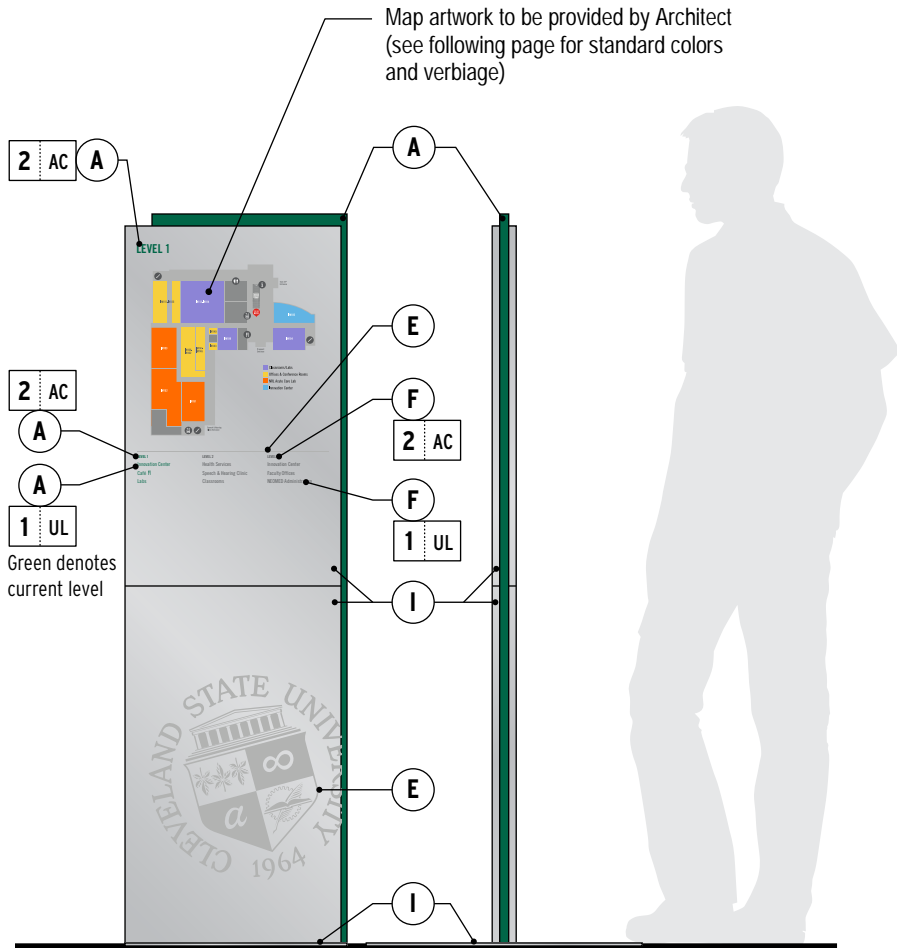

FRONT ELEVATION
SCALE: 3/8" = 1'-0"

SIDE ELEVATION
SCALE: 3/8" = 1'-0"

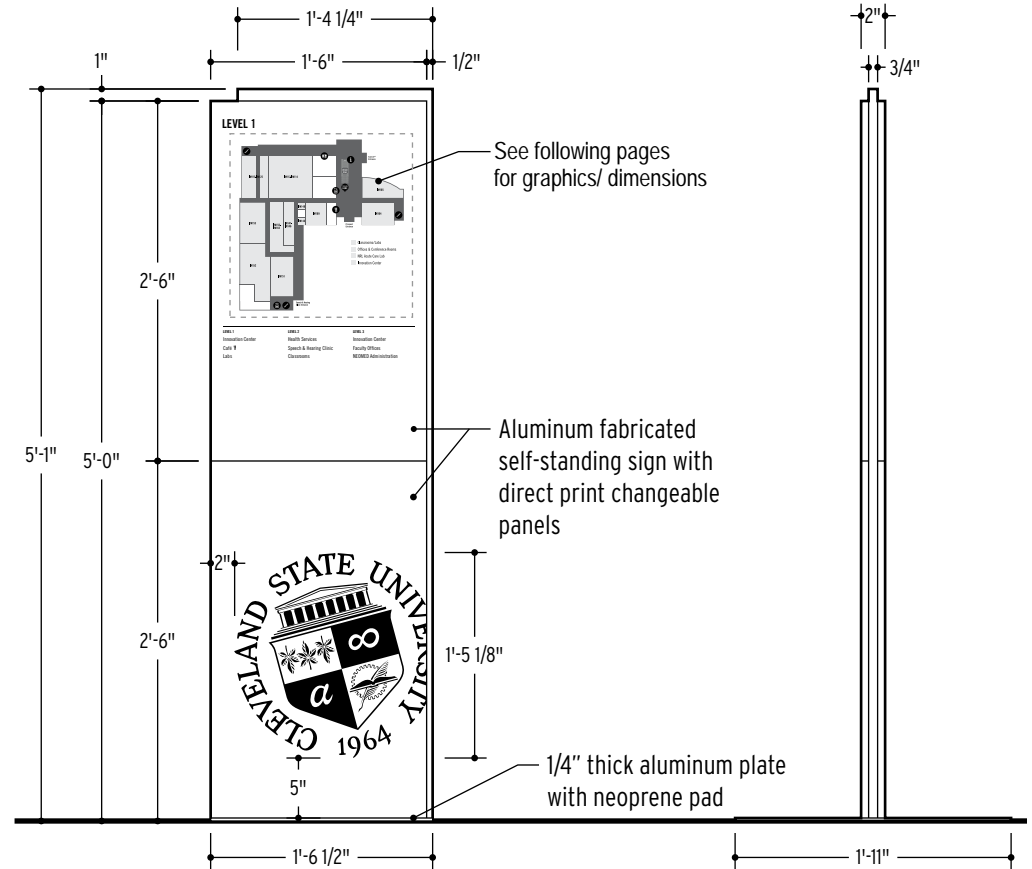
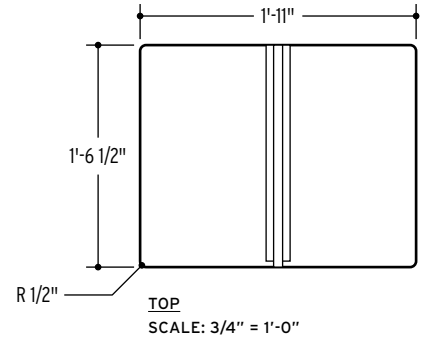

FRONT ELEVATION
SCALE: 3/4" = 1'-0"

SIDE ELEVATION
SCALE: 3/4" = 1'-0"

SECTION 4

F3 Free-Standing Directional

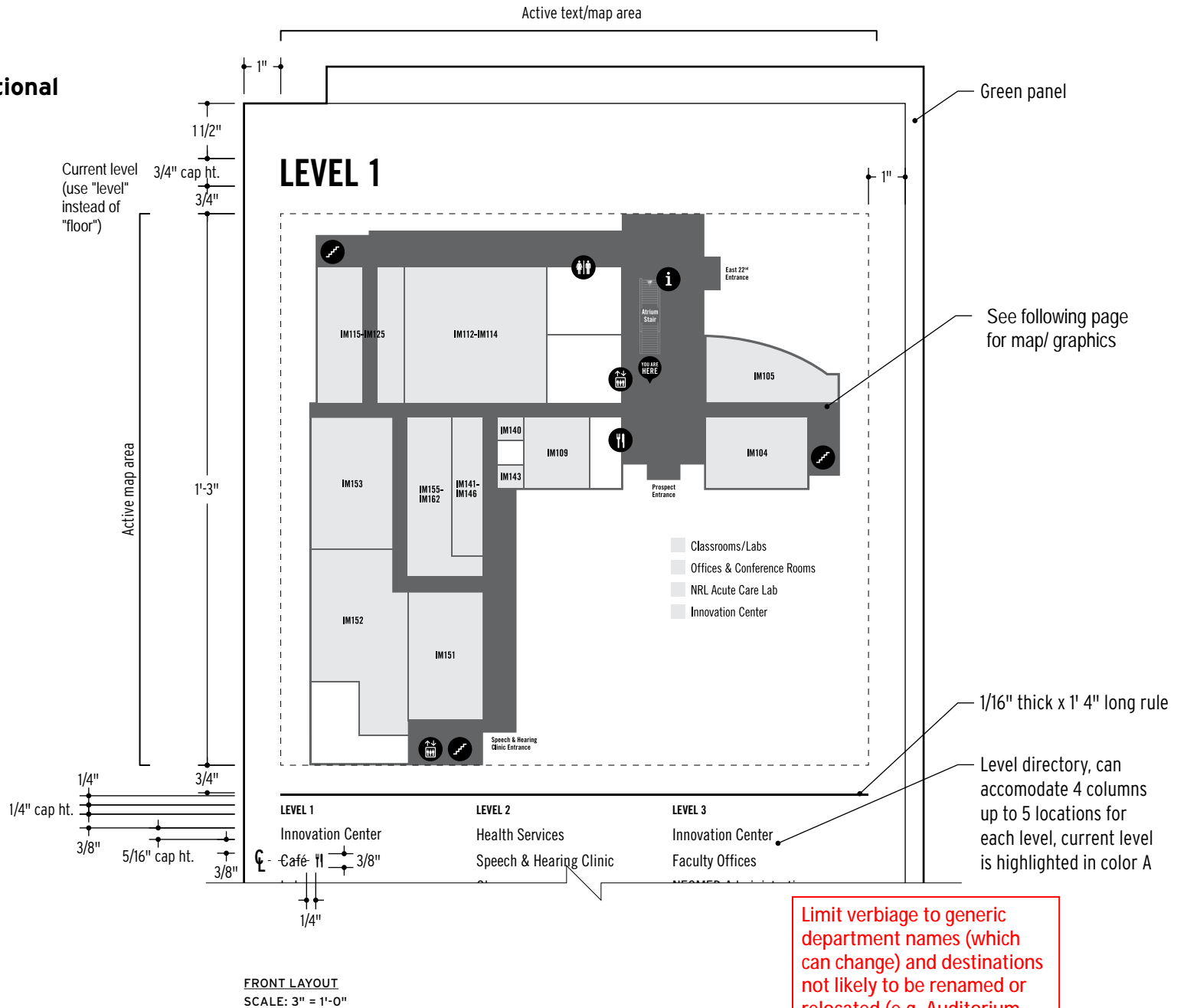



Project Architect is responsible for providing graphic map for each floor. CSU can provide basic CAD files only (no color blocks or symbols). CSU PM and Interior Designer to approve final maps prior to production.

see page 6 for standard symbols

see page 7 for standard colors

COLORS APPLY TO DIRECTORY MAPS ONLY:

- Classrooms / Labs = purple (P)
- Offices & Conference Rooms = yellow (O)
- Auditorium / Lecture Hall = orange (N)
- Project Specific = blue (J)
ie. Health & Wellness Clinic, Film Studio, Sports Venue

COLORS APPLY TO DIRECTORY MAPS and EVAC MAPS:

- Insert/background color = white (C)
- Corridors = medium gray (E)
- Building core/rooms = medium-dark gray (PMS 423)
- Symbols = dark gray (F)

SECTION 4

Interior Sign Drawings
Identification

SECTION 4

G1 **Flag-Mounted ID**

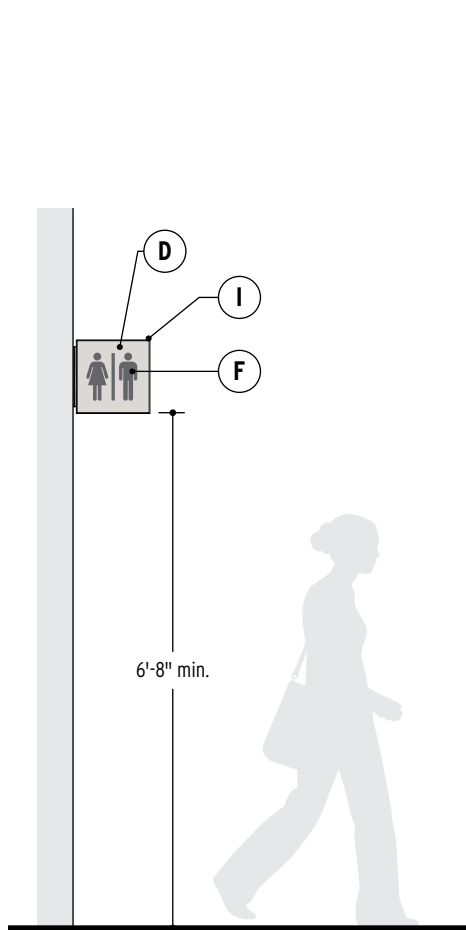

FRONT ELEVATION
SCALE: 3/8" = 1'-0"

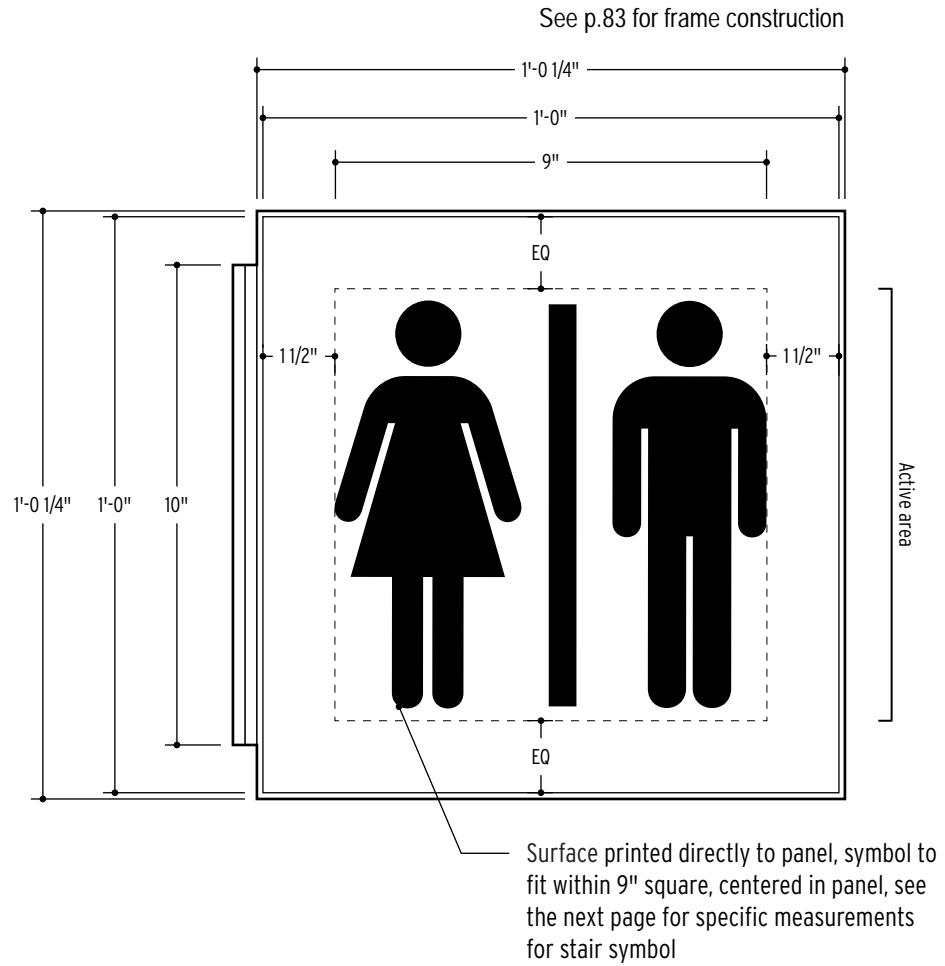

FRONT DETAIL
SCALE: 3" = 1'-0"

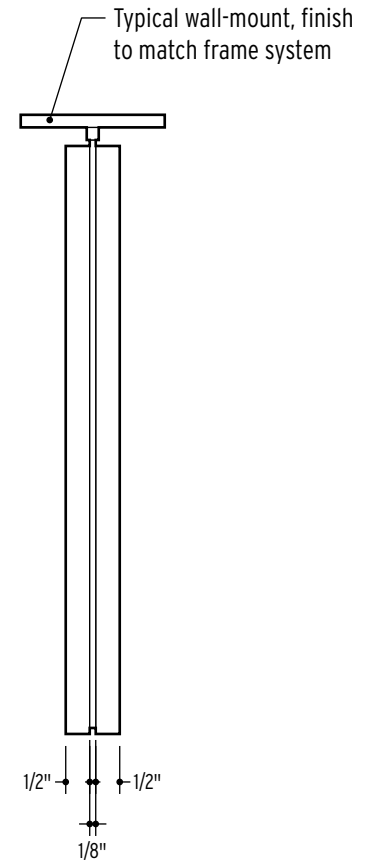

TOP DETAIL
SCALE: 3" = 1'-0"

SECTION 4

G1 Flag-Mounted ID

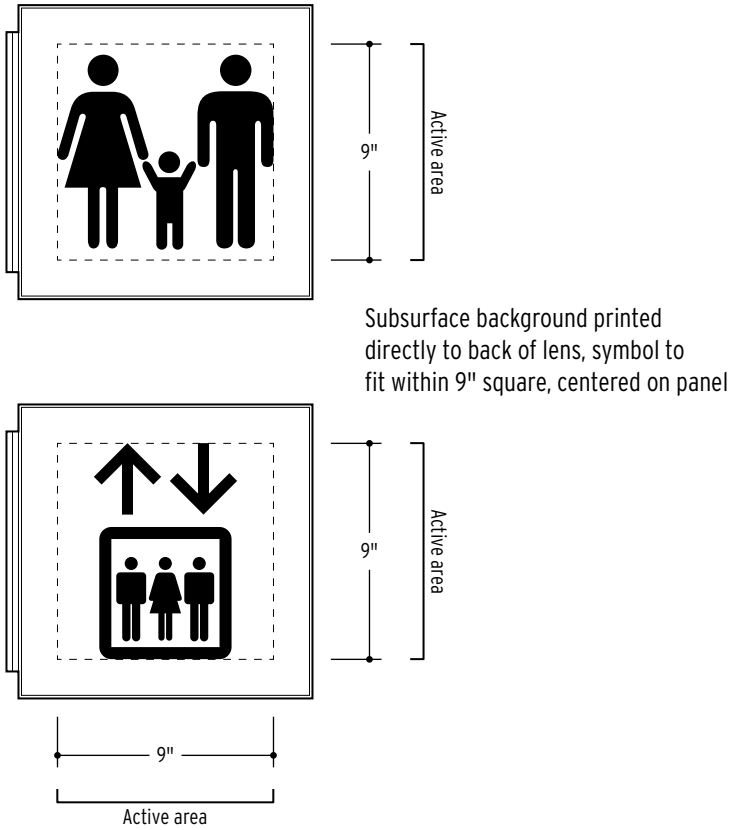

ALT FRONT DETAIL
SCALE: 1 1/2" = 1'-0"

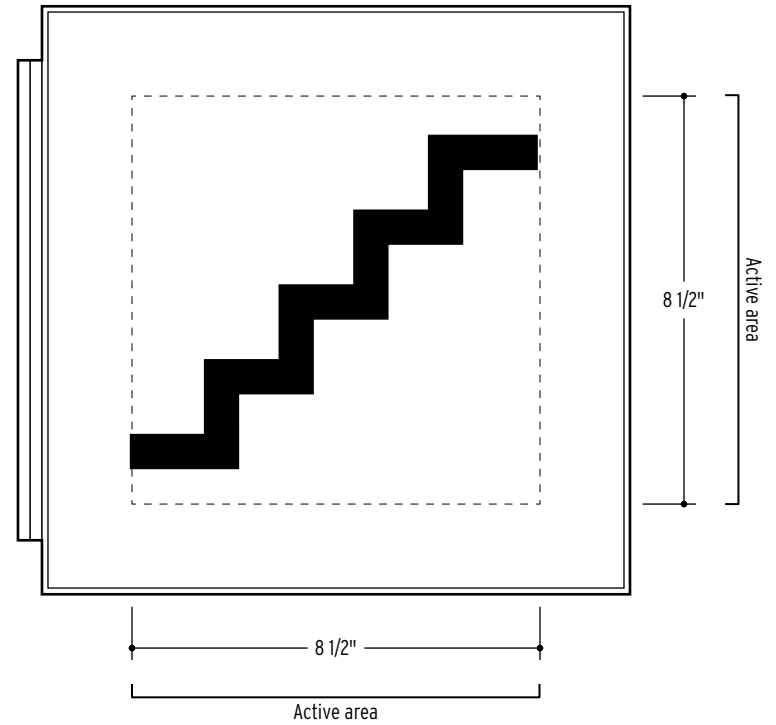

ALT FRONT DETAIL
SCALE: 3" = 1'-0"

SECTION 4

G2 Public Convenience ID

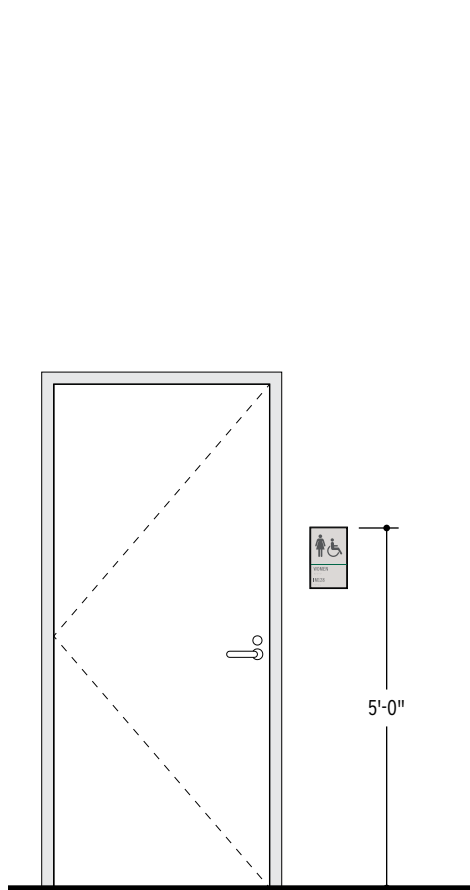

TYPICAL ELEVATION
SCALE: 3/8" = 1'-0"

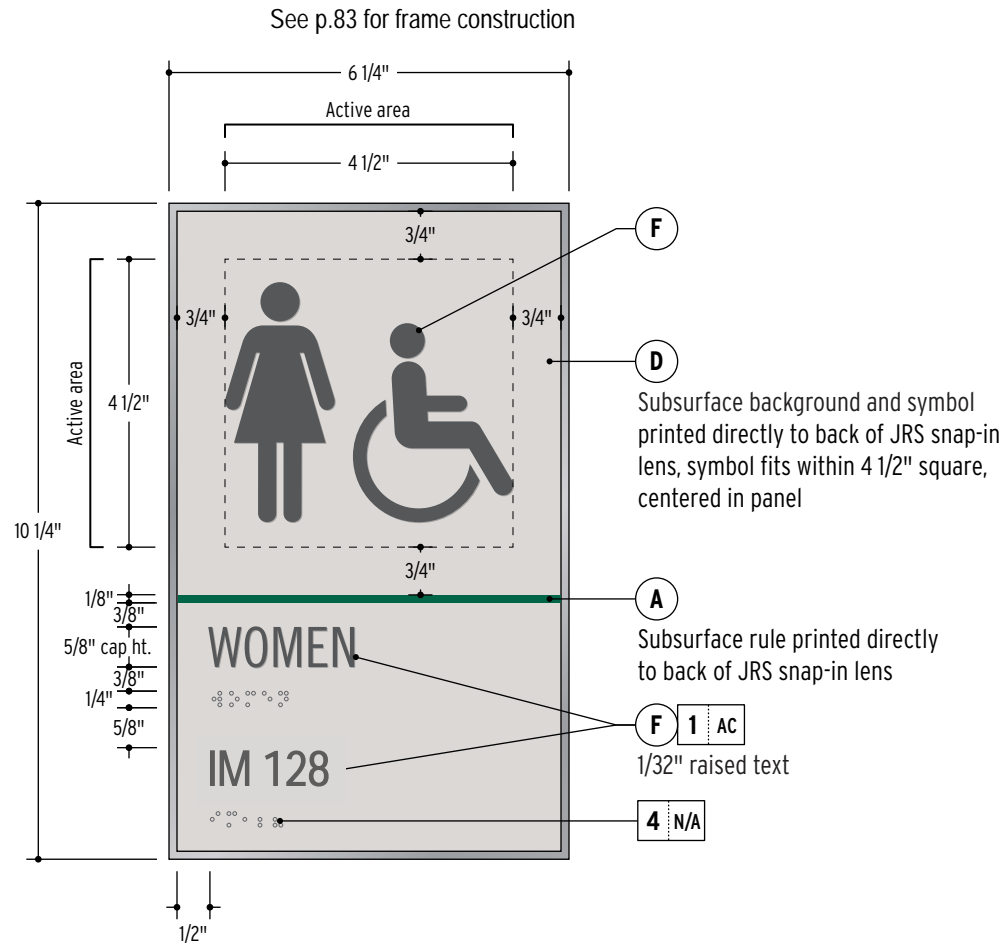

DETAIL
SCALE: 1" = 3"



SELECTED ALT MESSAGES
SCALE: 3" = 1'-0"

SECTION 4

G2 Public Convenience ID

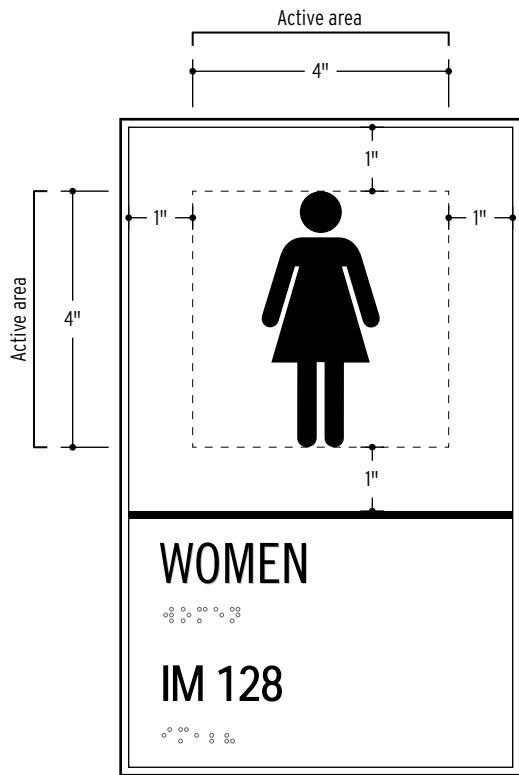

“Men”, “Women” and “Stair” symbols fit within 4" square, centered in panel

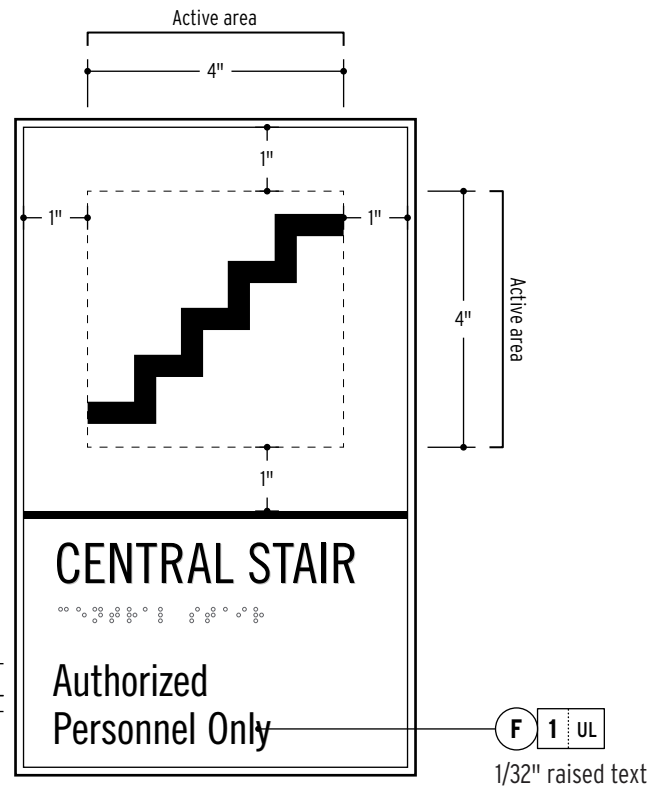
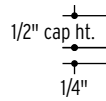

SELECTED ALT SYMBOL SIZES
SCALE: 1" = 3"



UV printed 1st surface
PMS 425 C (gray)

UV printed 1st surface
PMS 342 C (green)

Side View

1/16" Duet matte
clear acrylic painted
2nd surface PMS
Cool Gray 1 C

1/32" Duet charcoal
gray tactile

clear Grade II braille

satin silver
alum. frame

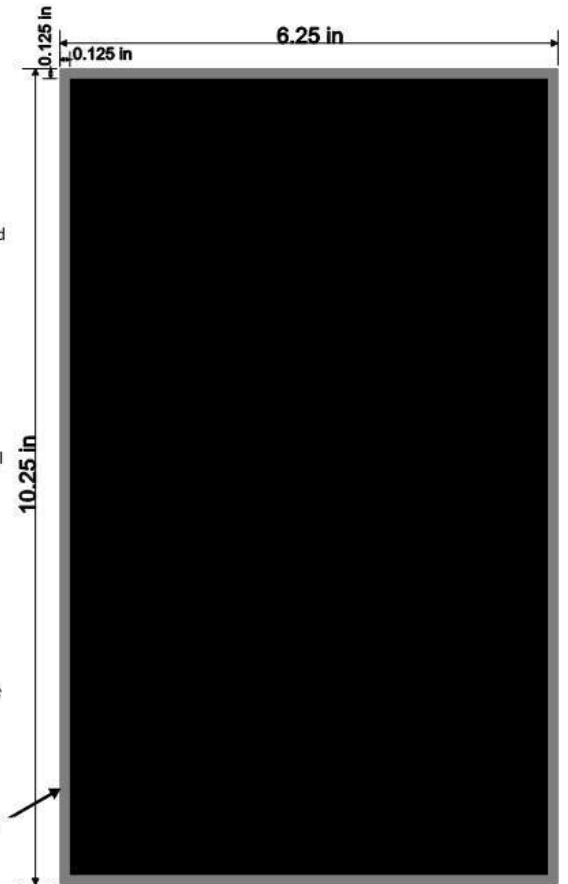

See p.83 for frame construction

SECTION 4

G3 Department ID

shall ONLY be used if amount of verbiage does not fit on standard 6x6 sign

Metal JRS frames are no longer available.
See new frameless design →

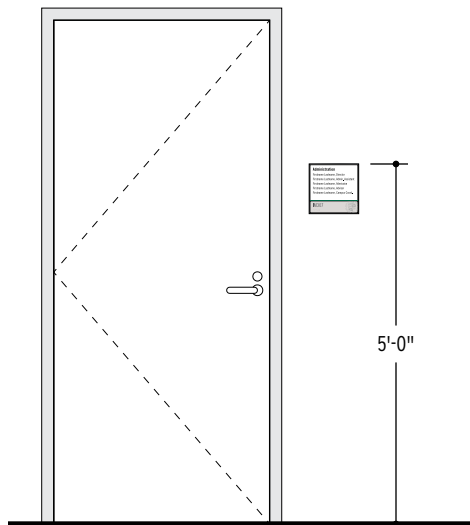
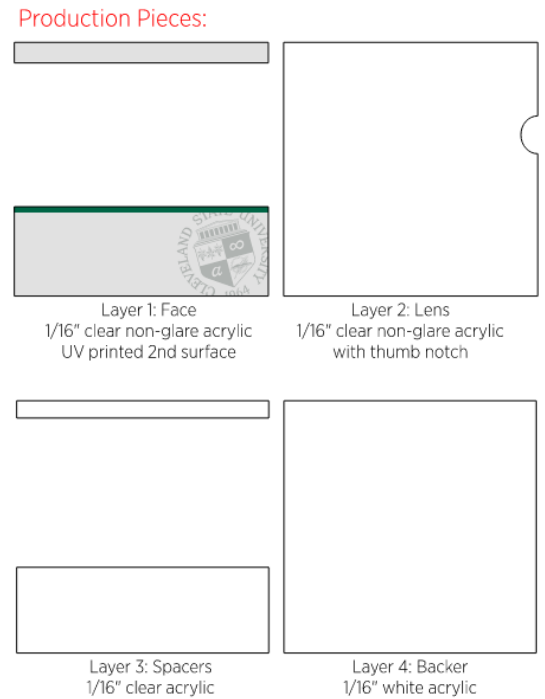
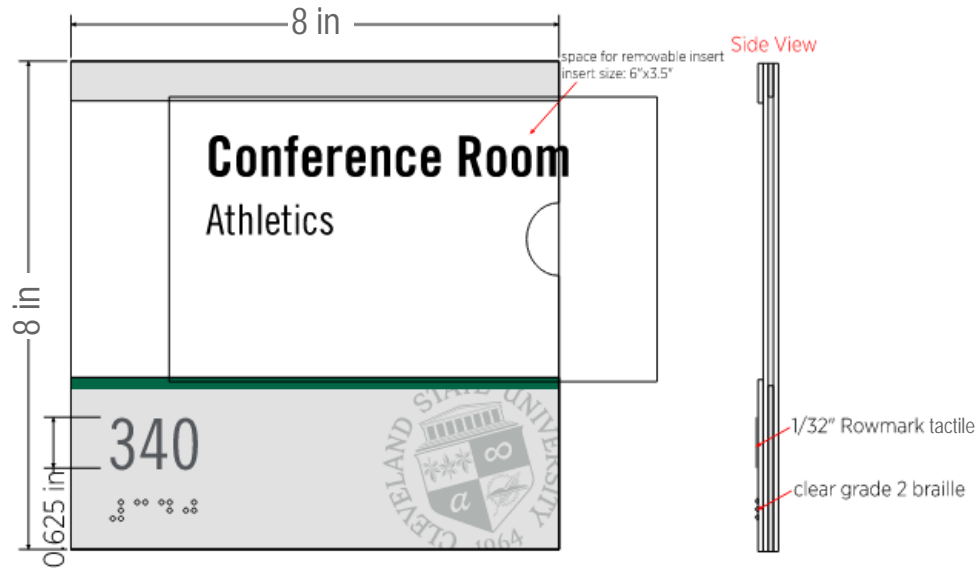

TYPICAL ELEVATION
SCALE: 3/8" = 1'-0"

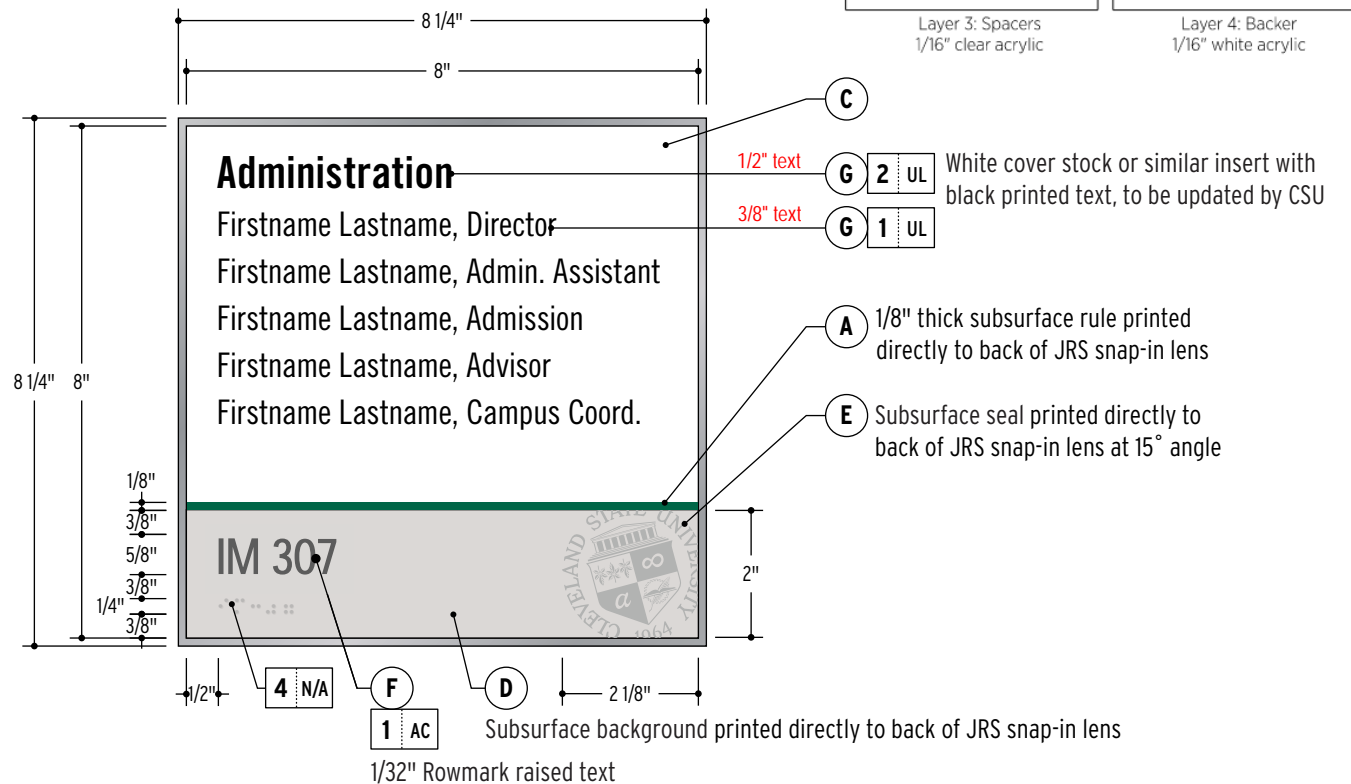

SECTION 4

G4 Public Room / Office ID

standard non-office room names:
 - Lactation Room
 - Enter at room 119 -->
 - Research Lab
 C. Weyman
 BGES

Metal JRS frames are no longer available.
 See new frameless design →

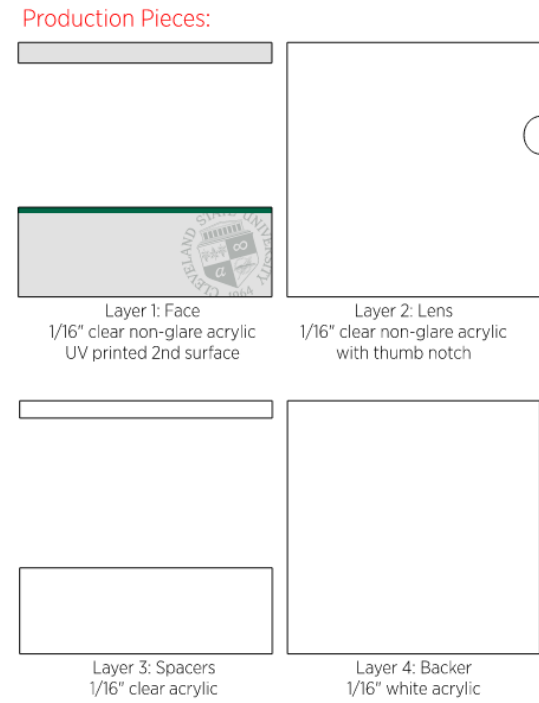
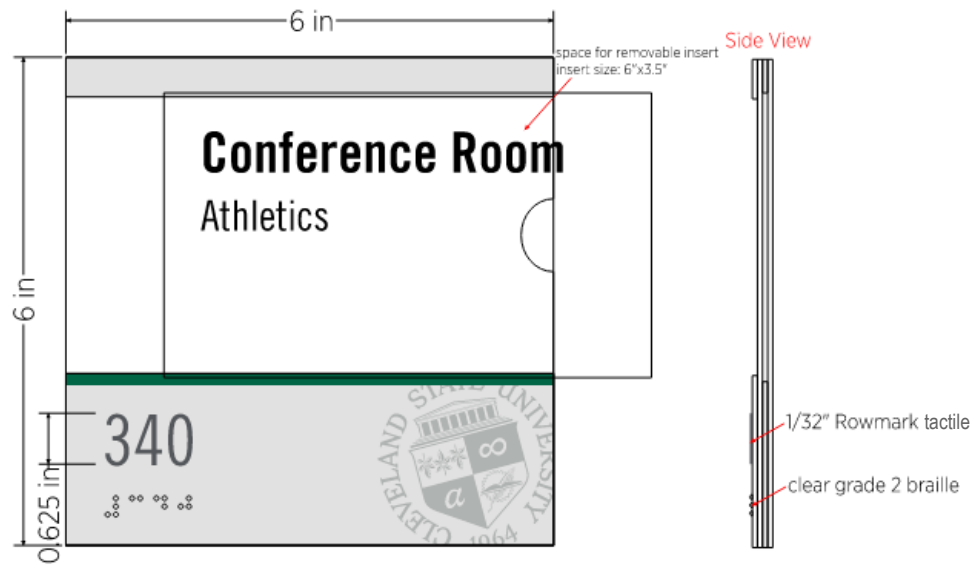

See p.83 for frame construction

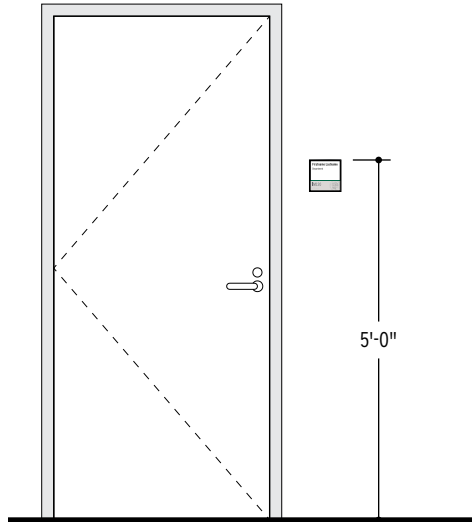

TYPICAL ELEVATION
 SCALE: 3/8" = 1'-0"

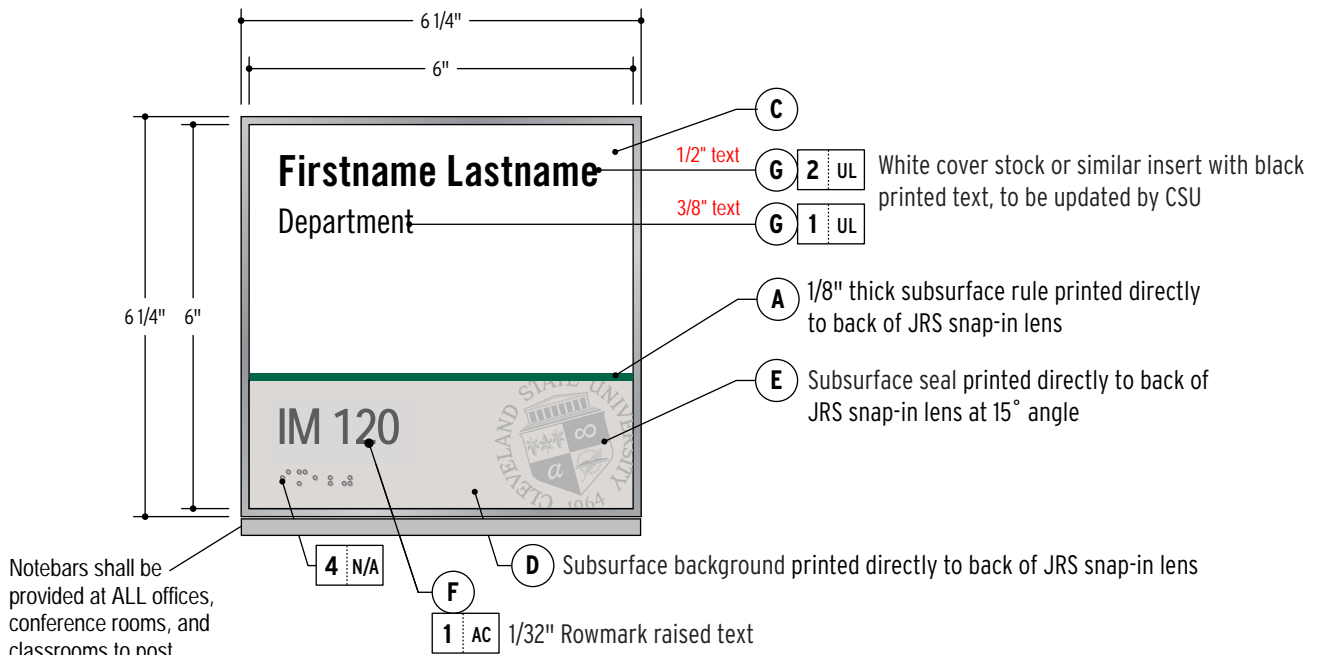

DETAIL
 SCALE: 1" = 3"

SECTION 4

G5 Operational Room ID

STANDARD ROOM NAMES:

- Custodial
- Electrical
- Mechanical
- Telecom
- Utility (use if more than one trade is housed within same room)

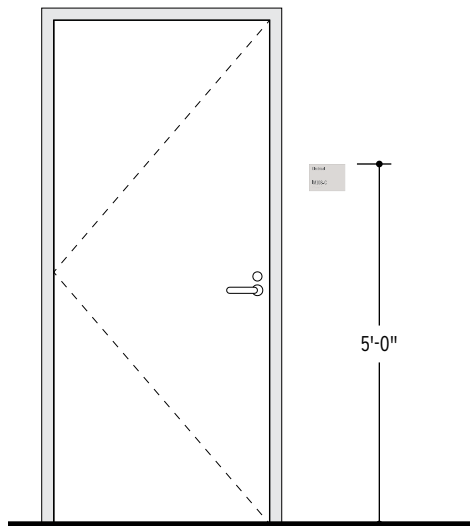

TYPICAL ELEVATION
SCALE: 3/8" = 1'-0"

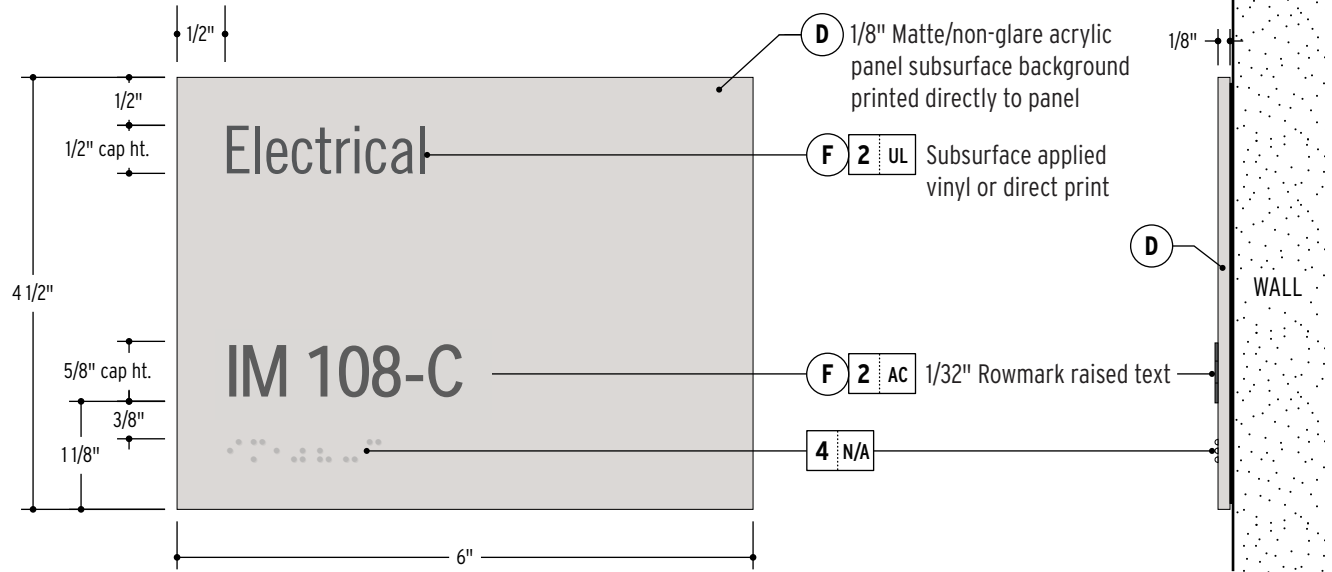

DETAIL
SCALE: 1" = 2"

SECTION
SCALE: 1" = 2"

SECTION 4

G6 Name Plate

Metal JRS frames are no longer available.

Provide new frameless design similar to sign types G3 + G4, or aluminum panel-hung unit similar to this →

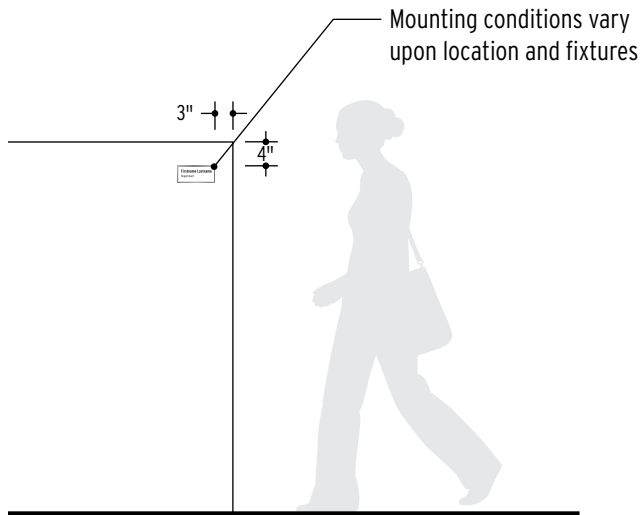

TYPICAL ELEVATION (CONDITIONS WILL VARY)
SCALE: 3/8" = 1'-0"

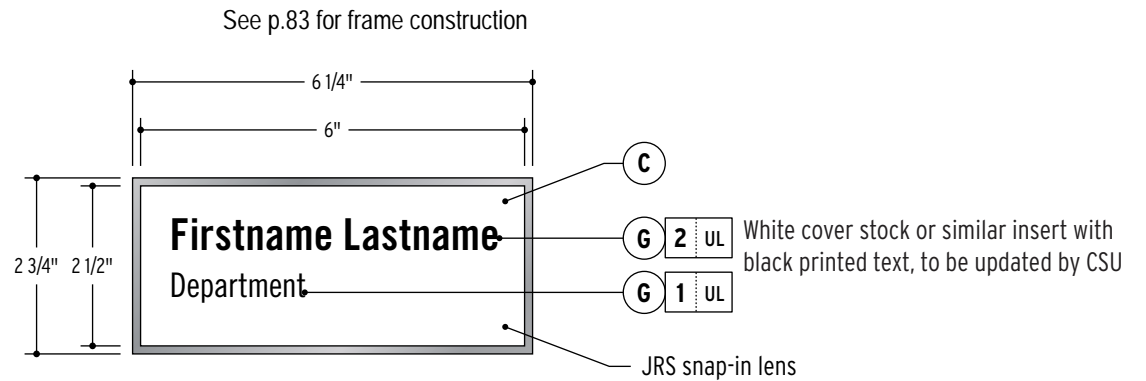

DETAIL
SCALE: 1" = 3"

SECTION 4

Interior Sign Drawings
Regulatory

SECTION 4

H1 Evacuation Plan

- Production Clarifications:
- the snap in lens is clear
 - the header and footer are printed on the back of the lens
 - only the header and footer background is light gray
 - the insert is white
 - the map and legend are printed on the insert so it can be updated as needed
 - similar to Room ID signs

Project Architect is responsible for providing graphic map for each floor. CSU can provide basic CAD files only (no color blocks or symbols). CSU PM and Interior Designer to approve final maps prior to production.

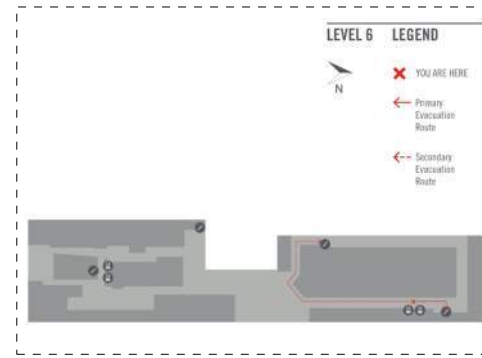

ALT. LAYOUT for long buildings

Header and footer, including red rule lines, subsurface printed directly to lens

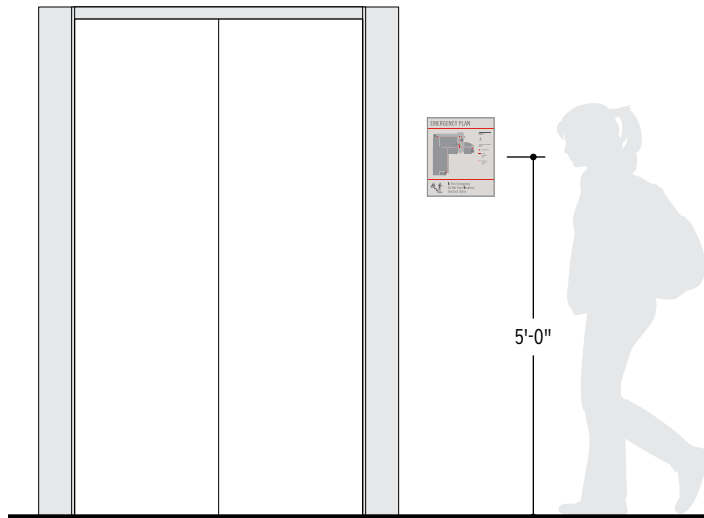

TYPICAL ELEVATION
SCALE: 3/8" = 1'

See sign type F3 (Directional Map) p.66A for colors

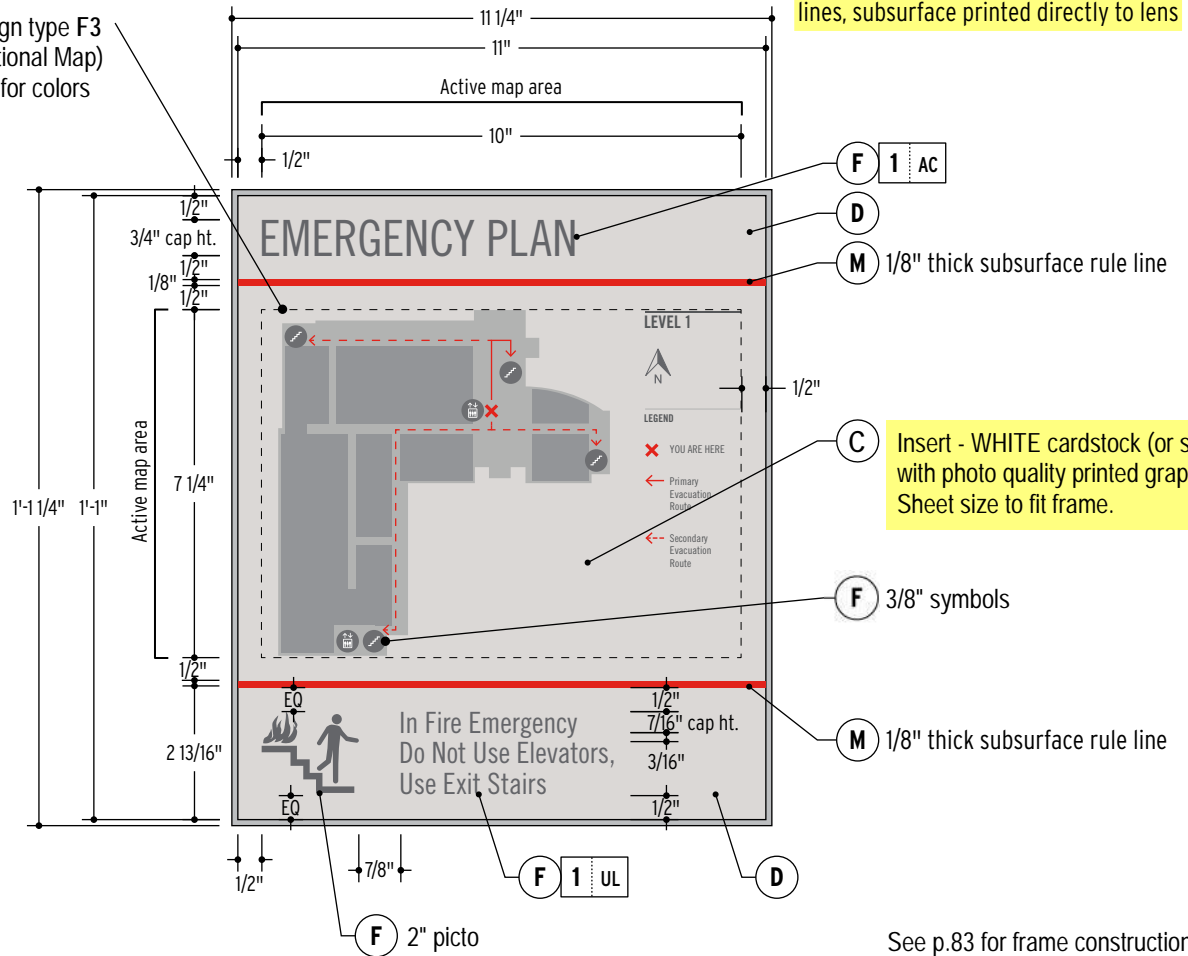

Insert - WHITE cardstock (or sim.) with photo quality printed graphics. Sheet size to fit frame.

DETAIL
SCALE: 3" = 1'

See p.83 for frame construction

SECTION 4

H2 Inside Stairwell Egress / Level ID

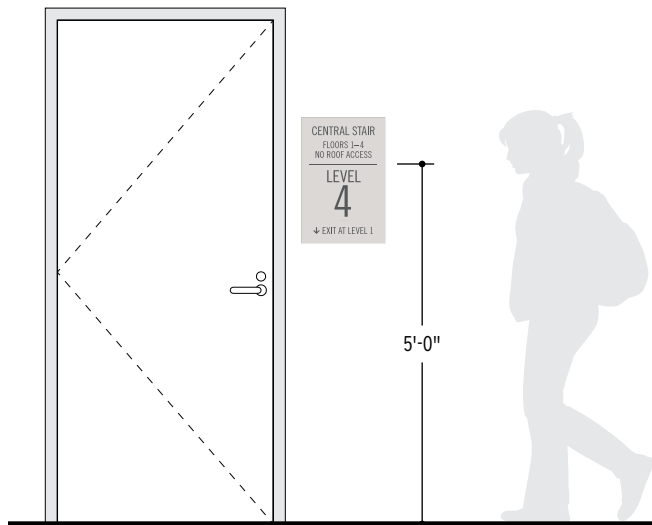

TYPICAL ELEVATION
SCALE: 3/8" = 1'

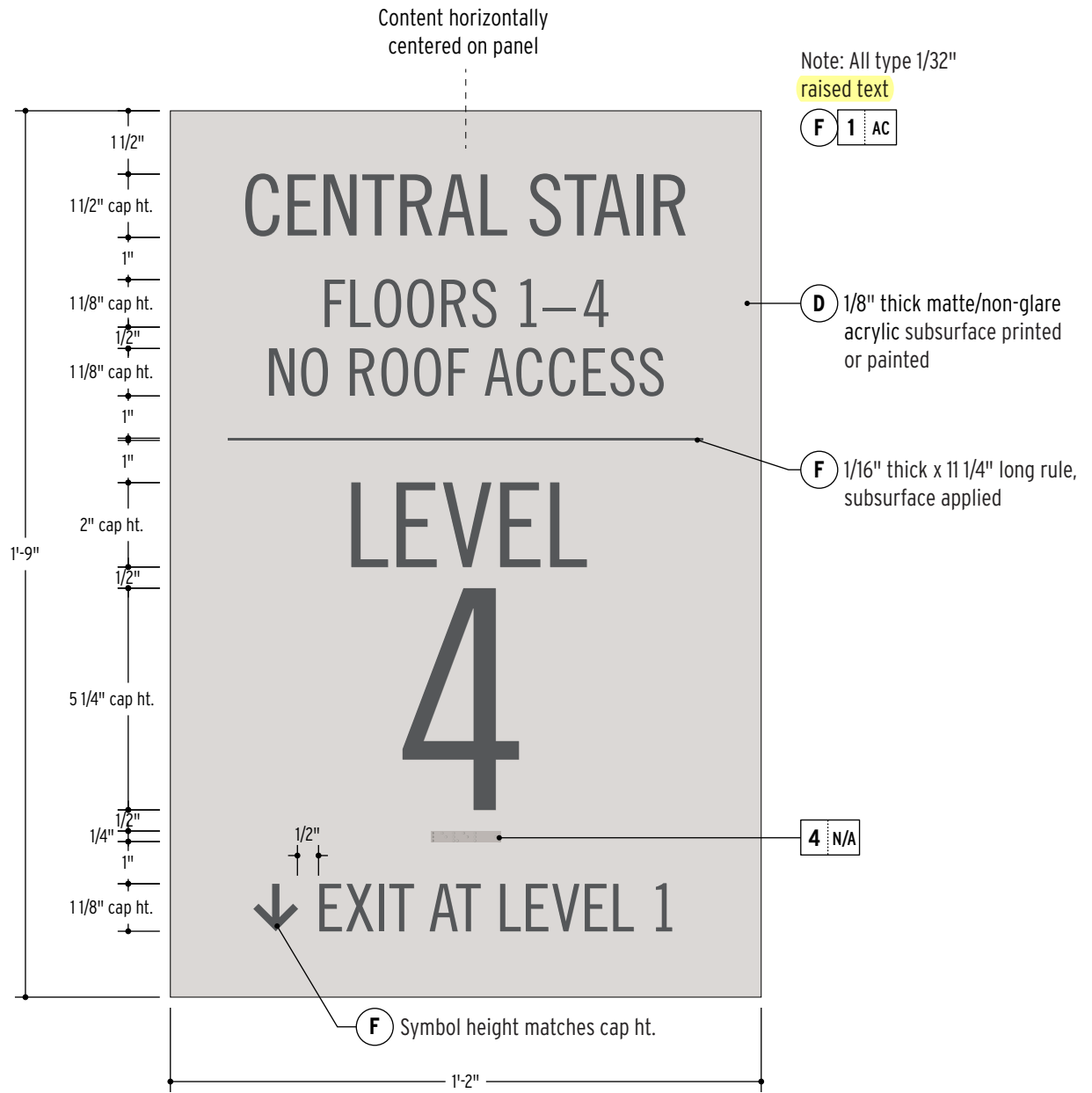

DETAIL
SCALE: 3" = 1'

SECTION 4

H3 Inside Stairwell Tactile Exit

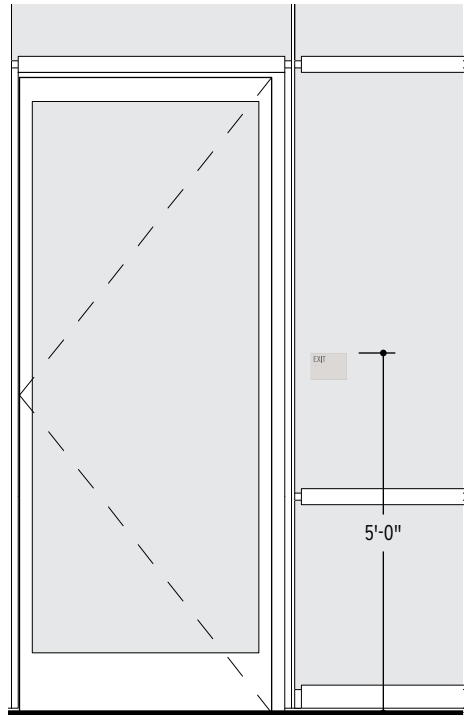

EXTERIOR ELEVATION
SCALE: 3/8" = 1"

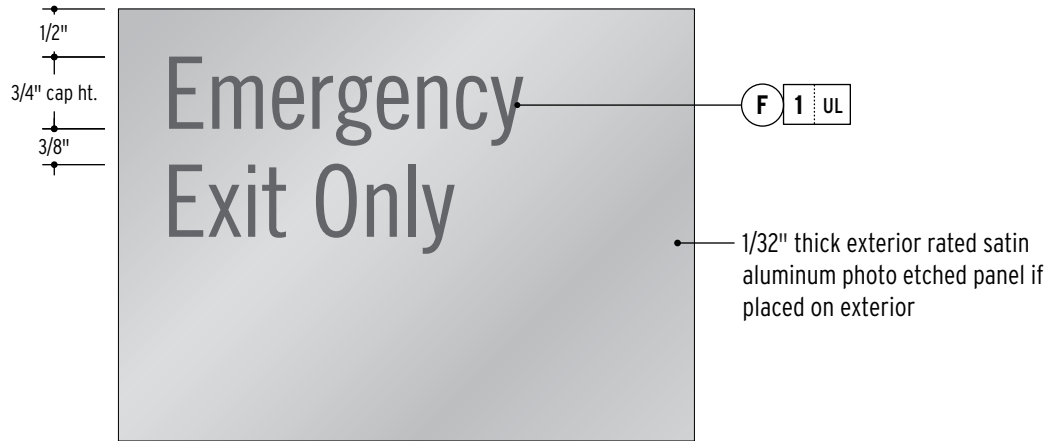

ALT DETAIL - EXTERIOR
SCALE: 1" = 2"

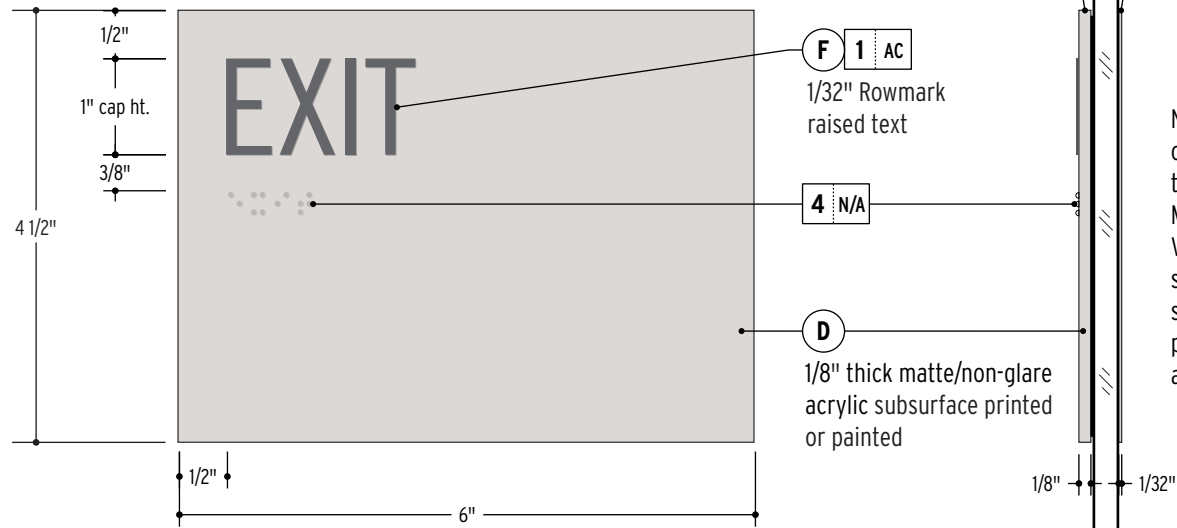

DETAIL
SCALE: 1" = 2"

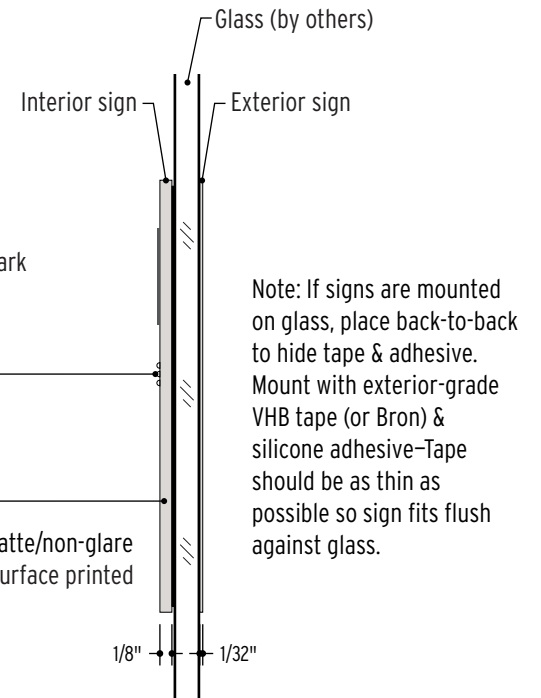

Note: If signs are mounted on glass, place back-to-back to hide tape & adhesive. Mount with exterior-grade VHB tape (or Bron) & silicone adhesive-Tape should be as thin as possible so sign fits flush against glass.

SECTION
SCALE: 1" = 2"

SECTION 4

H4 Maximum Occupancy

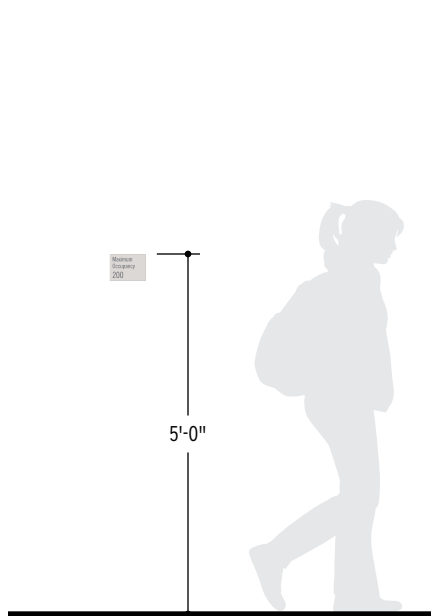

TYPICAL ELEVATION
SCALE: 3/8" = 1'

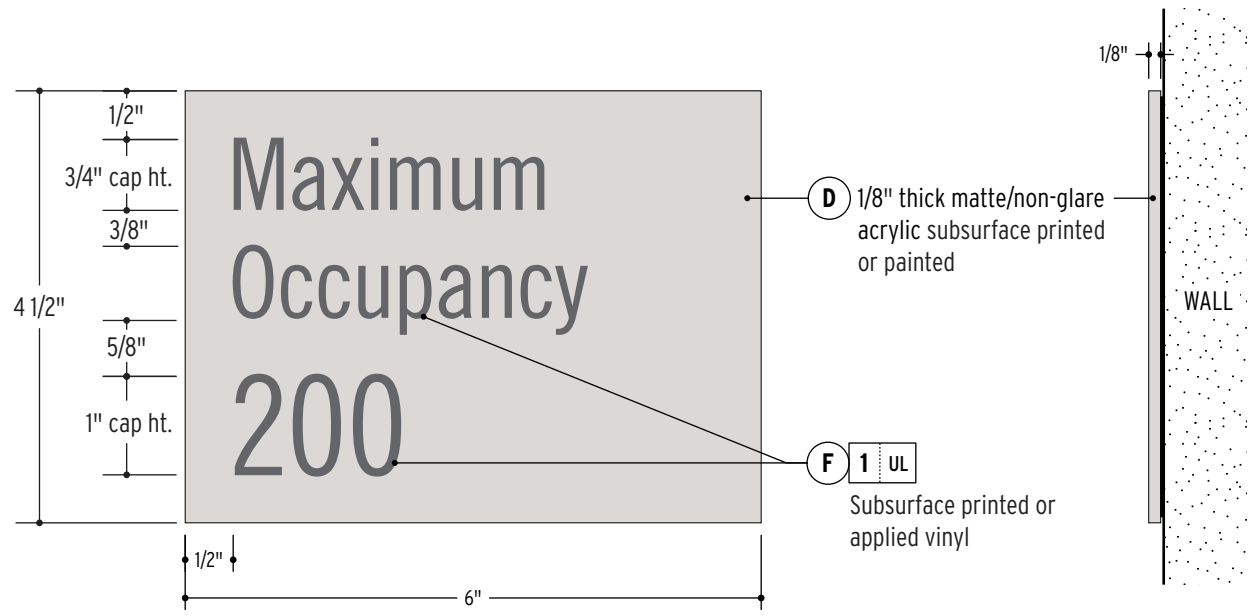

DETAIL
SCALE: 1" = 2"

SECTION
SCALE: 1" = 2"

SECTION 4

H5 Vinyl Messages/Graphics

Refer to sign type B4 for Department ID layout

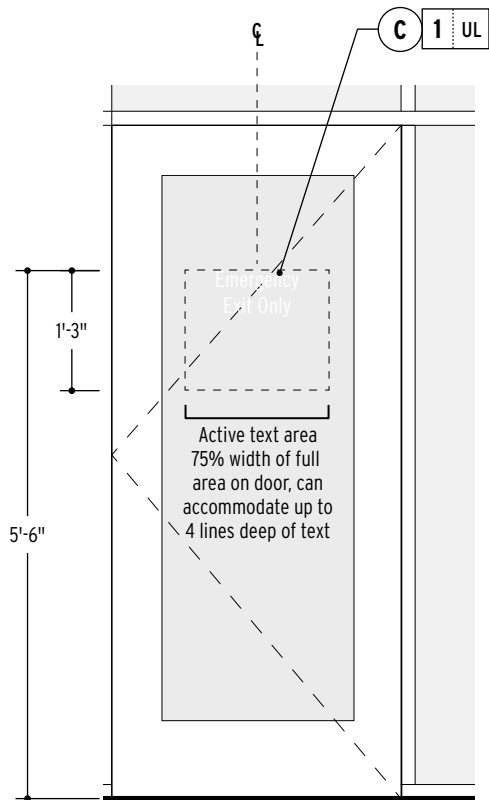

EXTERIOR ELEVATION
SCALE: 1/2" = 1'

2" cap ht.
1 1/4"
**Emergency
Exit Only**

DETAIL
SCALE: 3" = 1'

This sign type is for text necessary to convey Life Safety messages. Text to be white (C) on glass/ dark color door, (F) on light color door.

Additional decals provided by Duplicating:

MARKET ON EUCLID

Open 24/7 with the exception of 3am-4am

OPEN TO PUBLIC:
8am-6pm

CSU ID ACCESS ONLY:
4am-8am & 6pm-3pm

CLOSED FOR ALL:
3am-4am

EMERGENCY EXIT
ALARM WILL SOUND

H6 - Replacement Elevator Floor Level Tag

(similar to sign type G5 - Operational Room ID)

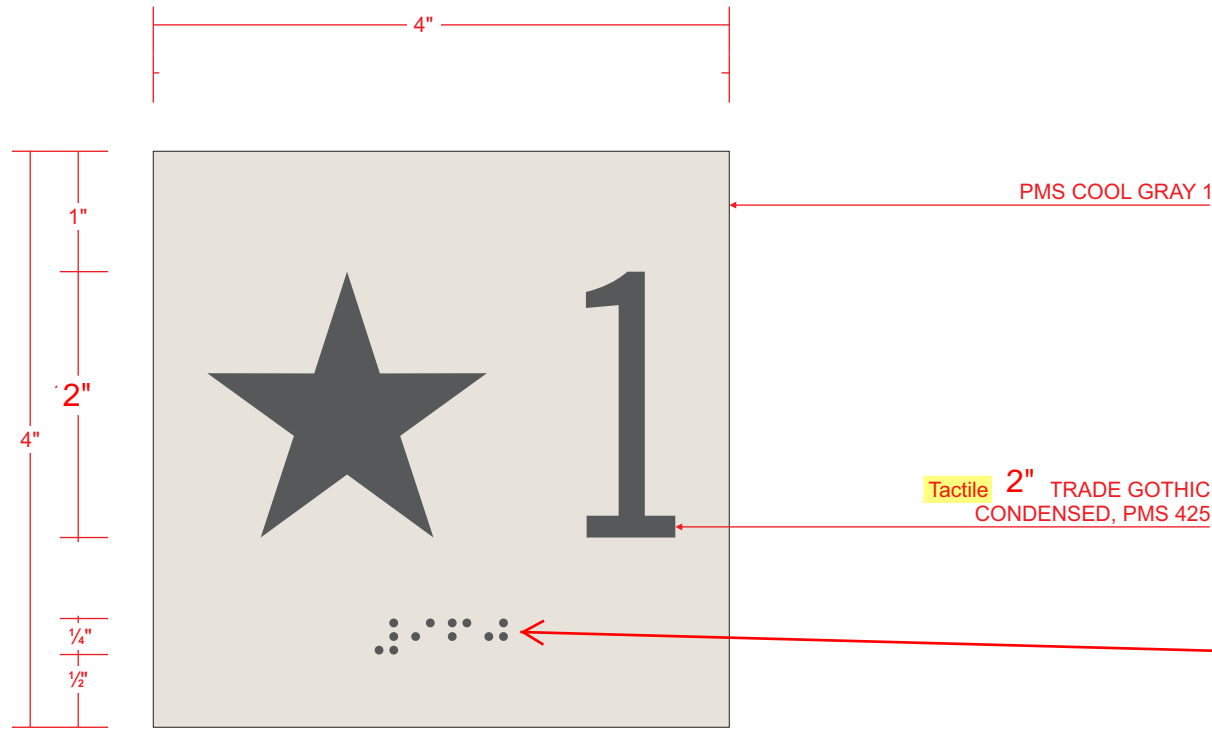

Provide (2) signs per floor.



Coordinate floor level designations with numbering system in existing elevator cab.

Install centered on existing elevator door jamb, both sides.

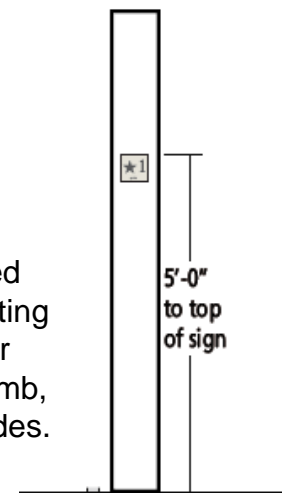

Sign Type H6-B Elevator Identifier Tag - jamb

PMS 425 C
(dark gray)

PMS Cool Gray 1 C
(light gray)

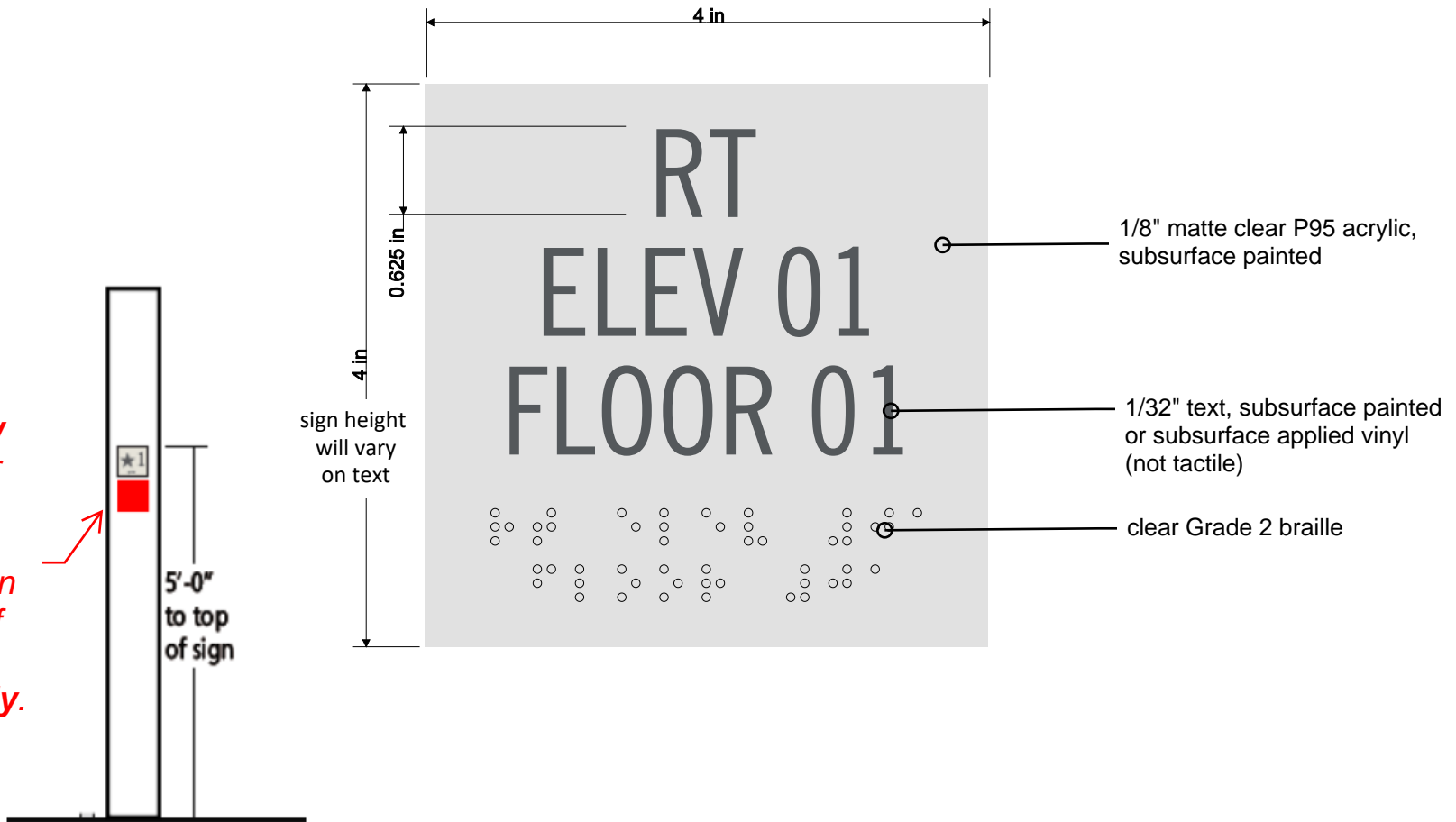

Sign Type H6-C Elevator Identifier Tag - cab

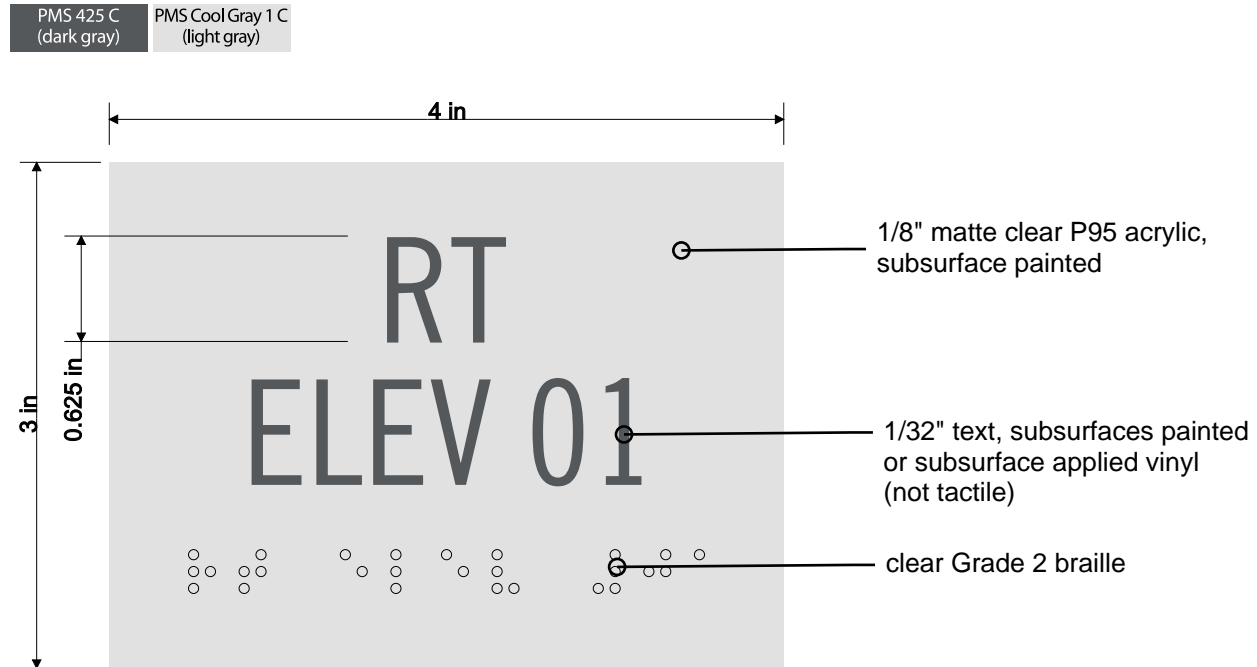

to be installed below control panel

J1 - Room Donor Plaques

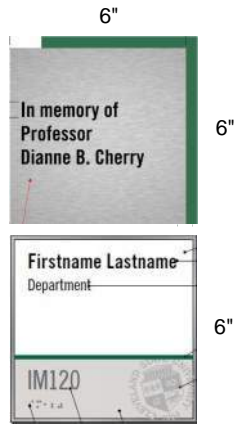

DONOR PLAQUE - alternate design
installed above room sign

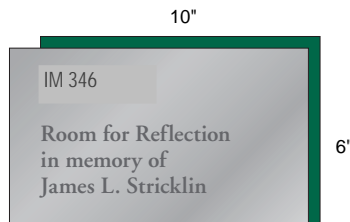

DONOR PLAQUE - original design

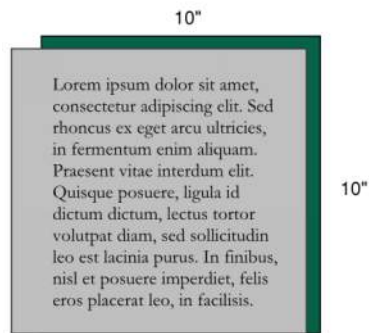

DONOR PLAQUE - inscription

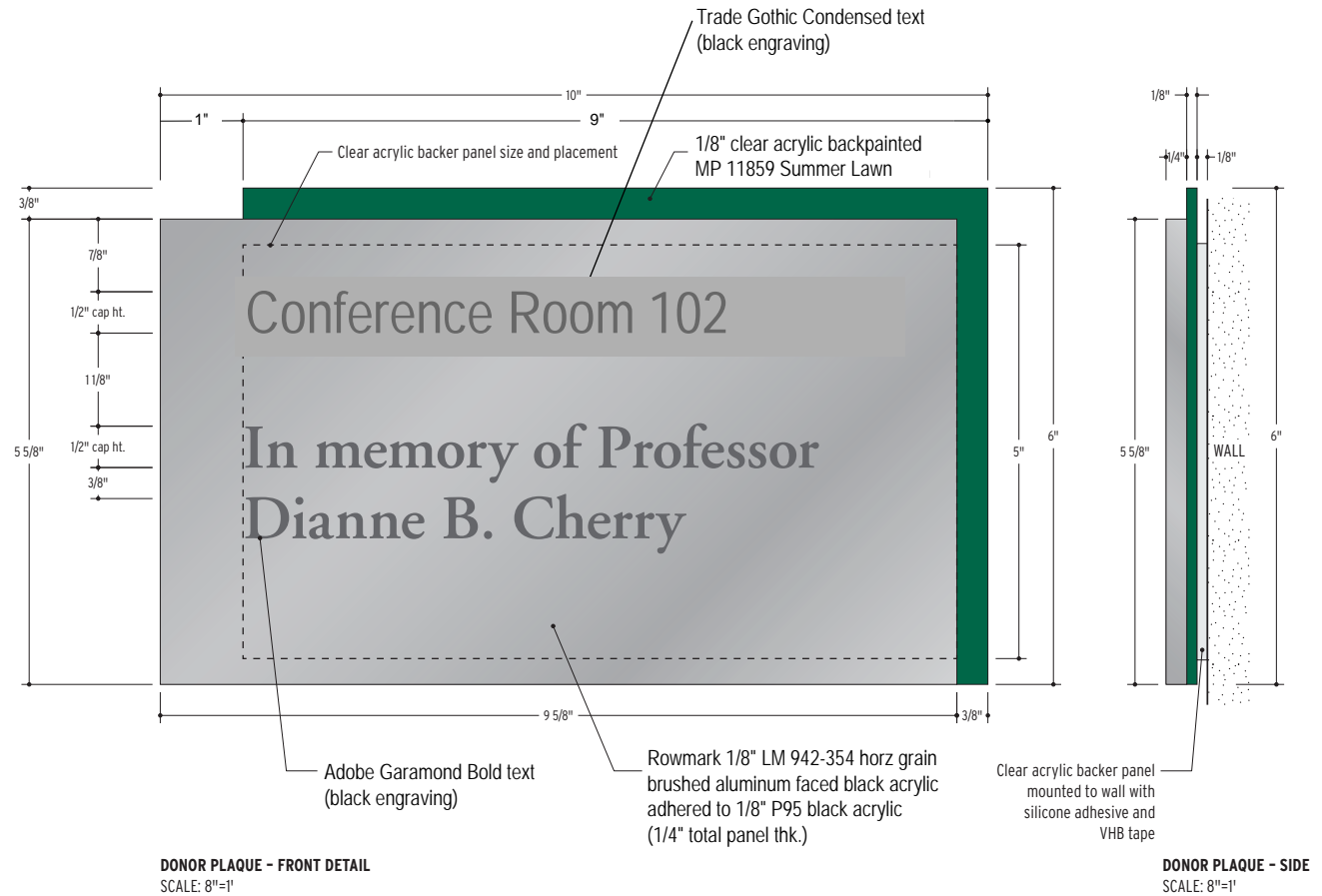

Tree Donor Plaque

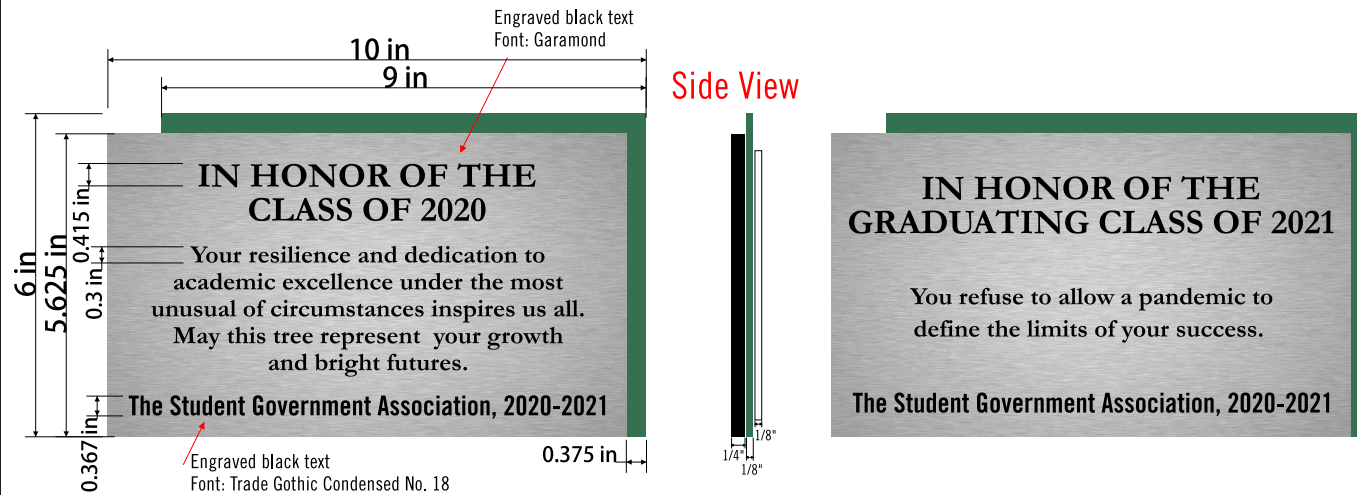

example of outdoor sign on black post:



Signs mounted to a 2"x2" square black post with a 35 degree cut (post and installation included)

J2 - Donor Name Plate

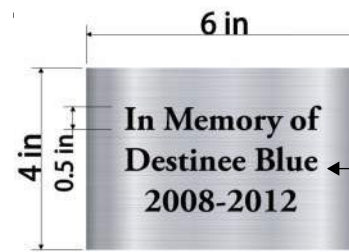

Material: engravable brushed aluminum faced black acrylic
 Size: 1/8" thk.
 (same as room donor plaques)

Donor Name Plate
 Font: Adobe Garamond Bold
 Size: 1/2"H
 (same as donor name on room donor plaques)

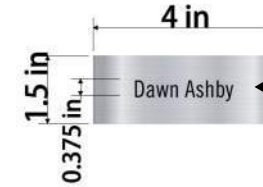

Student Name Plate
 Font: Trade Gothic Condensed
 Size: 3/8"H
 (same as donor name on room donor plaques)

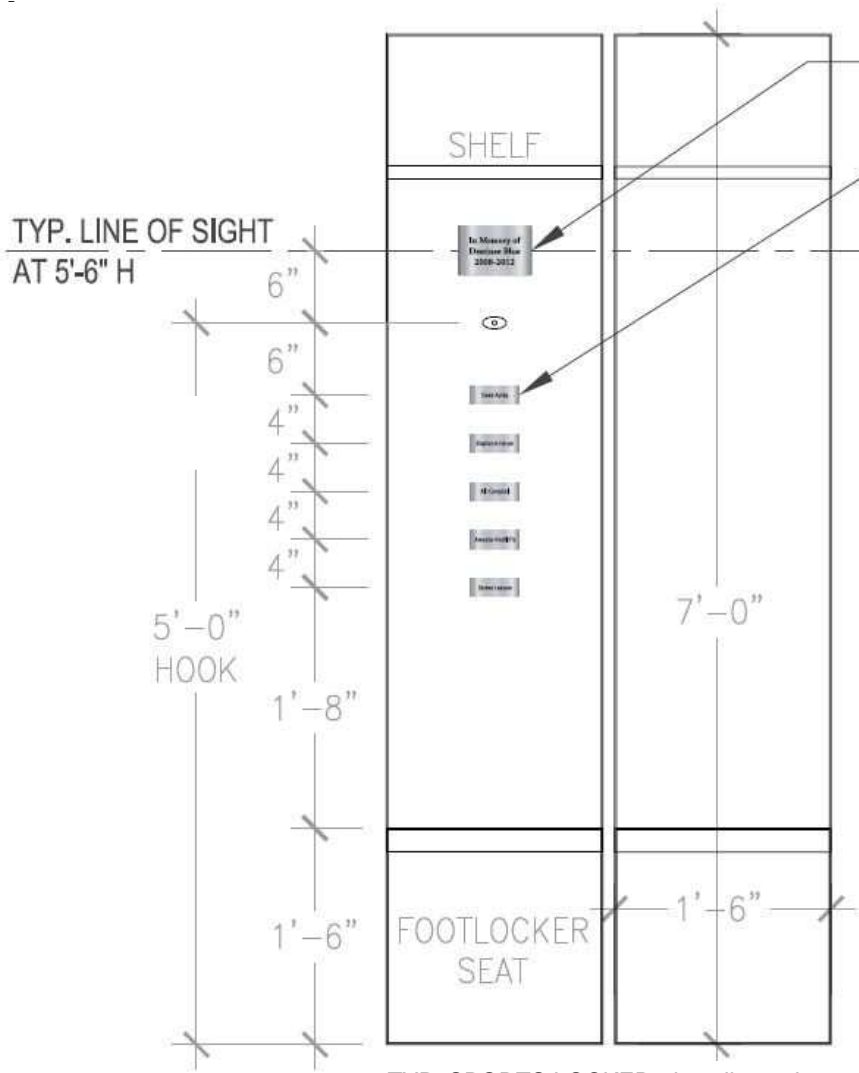

TYP. SPORTS LOCKER - install template

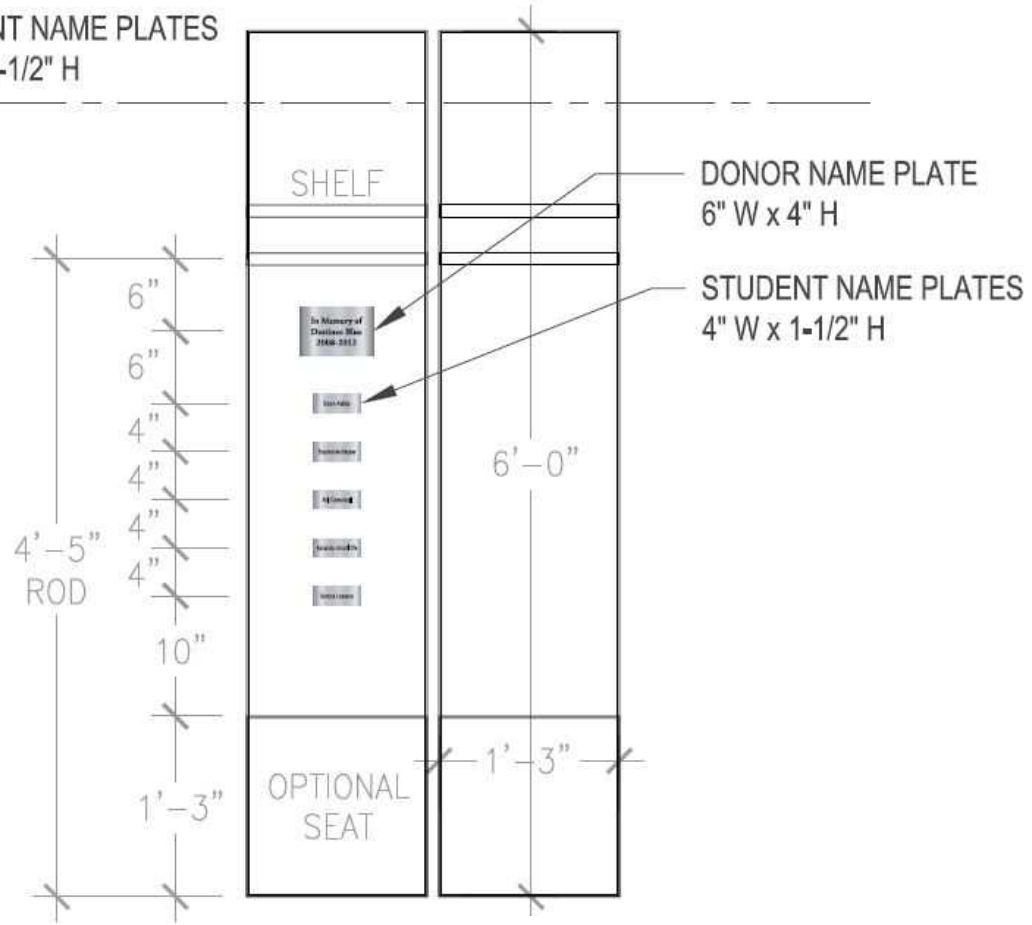

ALT. LOCKER - install template

SECTION 5

Appendix

Appendix A

Appendix B

Appendix C

Appendix A

Typical Sign Frame Construction

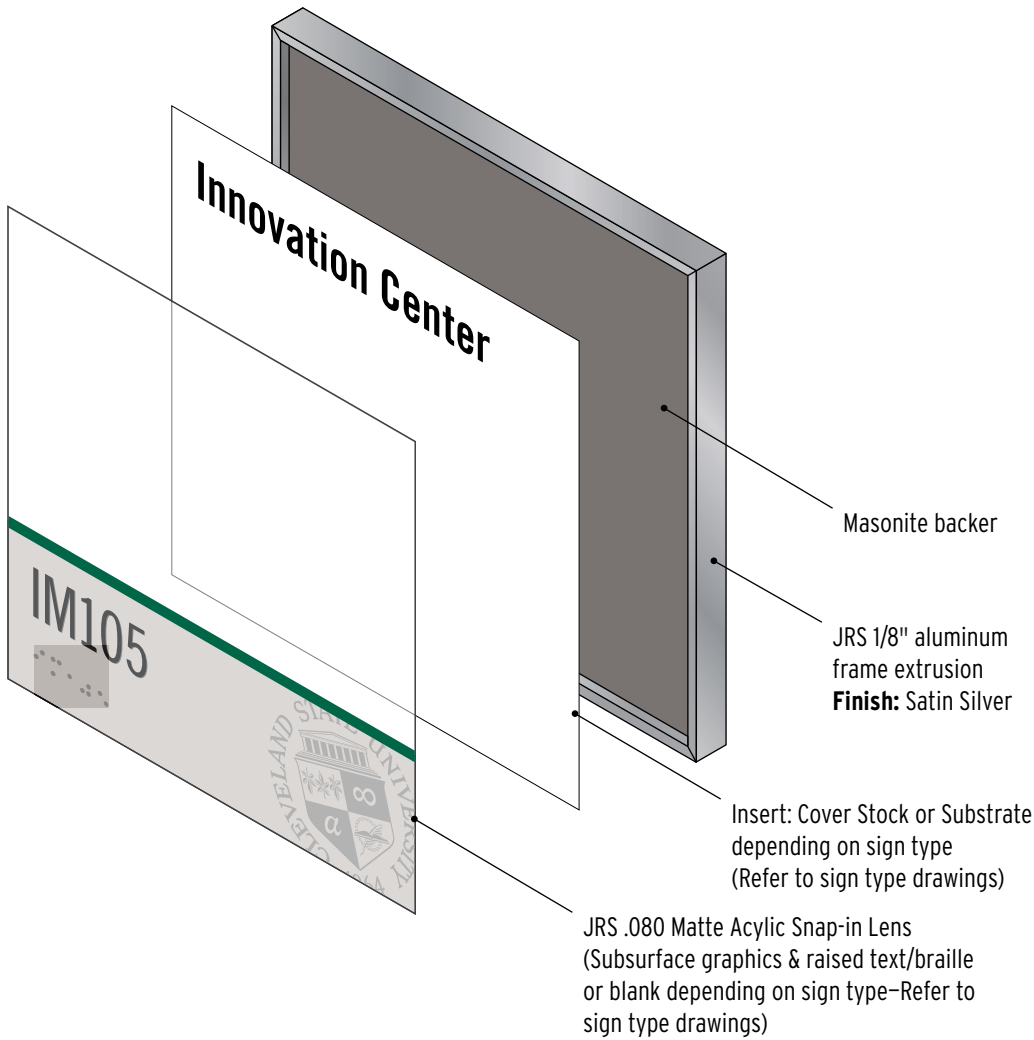

EXPLODED VIEW - TYPICAL FRAMED SIGN CONSTRUCTION
NOT TO SCALE

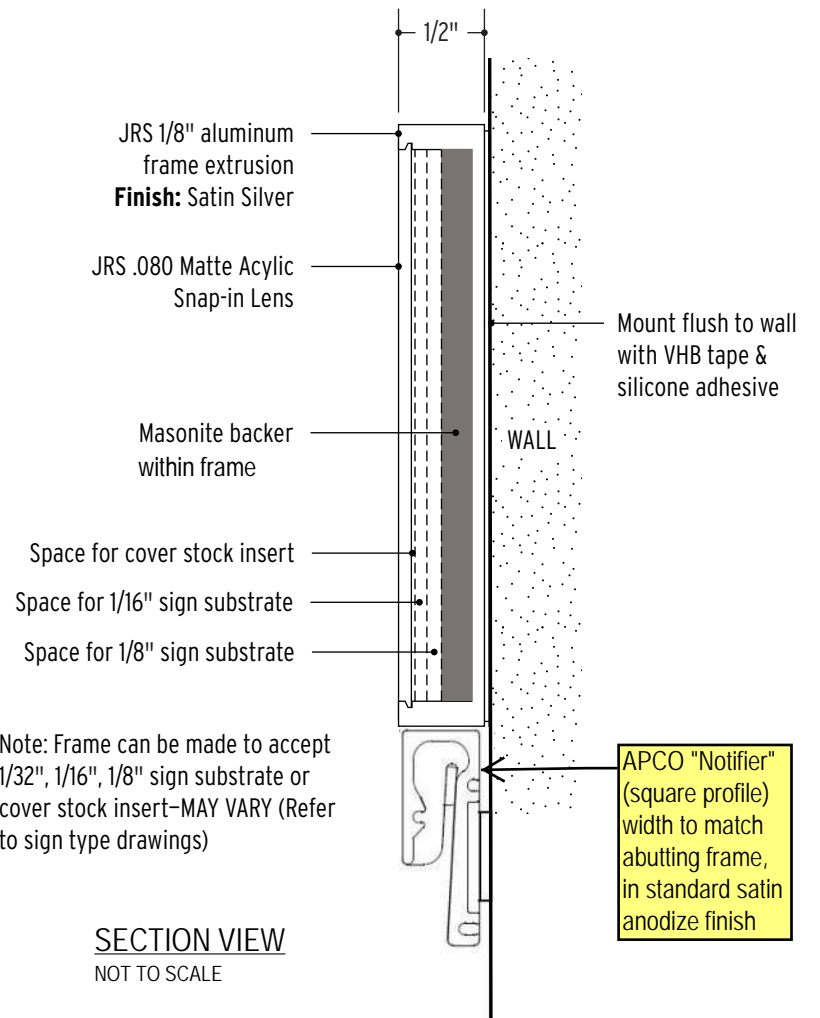

SECTION VIEW
NOT TO SCALE

Rendering

Project:
Cleveland State University

Date: 04.24.17 Drawn By: KS

Filename:
CLE0004_155136_RND_rev1

Design Review By:
DG

Revisions:
03.07.18AKD update finishes

Adapt

Notes:

- Sign copy shown is for sample purposes only.
- Window backer if required: to match face material (same grain)
- Patterns & encapsulated acrylic sections may vary by sign

Product Approval

As Is As Noted

Approved By:

Date:

Rendering 1 of 1

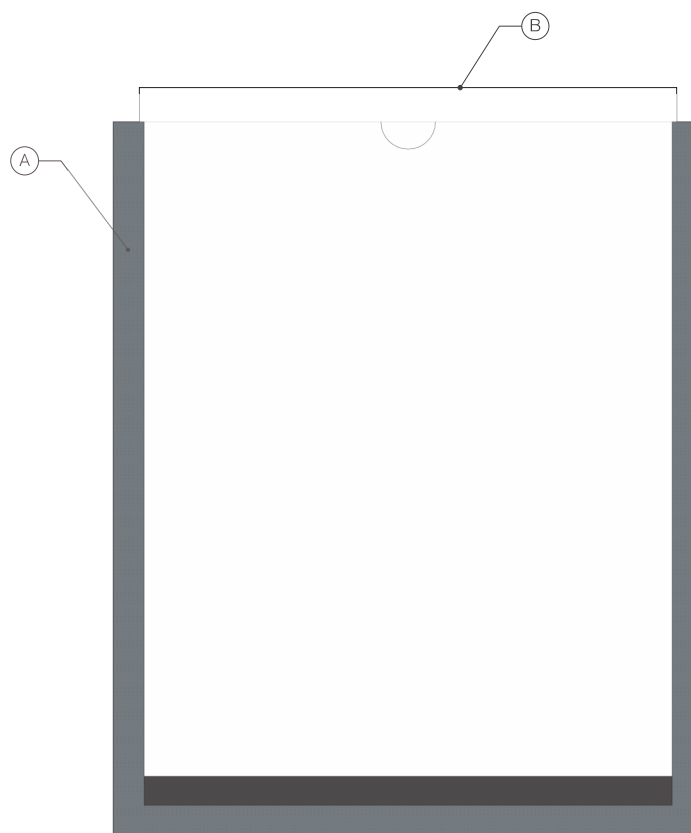

Type 0.2 Custom Notice Holder
9.5"w X 11.5"h
with thumbnotch

Letter size notice holders are standard at all Class Labs and Research Labs to display lab use/content information. (citadel microdot frame)

Tabloid size notice holders may be used in elevators/corridors to display event information. (satin silver frame)

Takeform Notice Holder

Face Finish



(A)

LS1097 Citadel Microdot

Insert



(B)

Client to provide insert

SECTION 5

Appendix B

Campus Building Names & Abbreviations

Refer to Campus Map posted on CSU's website for current list of buildings/ codes

AMC Annex	AA	Heritage Hall	HA	Plant Services	PS
Parker Hannifin Administration Center	AC	Julka Hall	JH	Recreation Center	RC
Allen Theater	AT	Law Building	LB	Rhodes Tower	RT
Art Gallery	AG	Law Library	LL	Rhodes West	RW
Business Building	BU	Library	RT	Science Building	SI
Campus Safety	CS	MAGNET Building	CM	Science & Research Center	SR
Center for Innovation in Medical Professions	IM	Main Classroom Building	MC	Student Center	SC
Chester Building	CB	Mather Mansion	MM	Union Building	UN
Chester Building Annex	CA	Middough Building	MB	Urban Building	UR
Cole Center	CE	Music & Communications	MU	Wallingford Building	WA
Euclid Commons	EC	Parker Hannifin Hall	PH	Wolstein Center	WO
Fenn Hall	FH	Parking & Transportation Services	EC	Wolstein Center Pavilion & Banquet Center	WP
Fenn Tower	FT	Physical Education	PE		
Health Sciences	HS	Plant Annex	PA		

SECTION 5

Appendix C

Performance Specifications

DESIGN INTENT DRAWINGS

The following drawings/specifications are for the sole purpose of visual design intent only and not intended for construction purposes. The Sign Contractor is responsible for engineering, design, construction technique, materials and installation.

The Owner (CSU Project Manager/Interior Designer) and Designer shall review the shop drawings only for conformance with general design intent, and will in no way be responsible or liable for any results of construction from working drawings, materials selection, shop drawings, contract documents or other agreements other than agreements with the Owner and Designer authorizing these documents.

Sign Contractor shall verify and be responsible for all dimensions and conditions shown in the Design Intent documents. If dimensions are missing or are unclear – consult the Designer for direction. The Designer must review shop details prior to fabrication.

PERFORMANCE SPECIFICATIONS INTRODUCTION

The purpose of these specifications is to serve as a reference which identifies materials, construction specifications, and quality controls, as well as signage contractor's responsibilities and obligations. Signage Contractor(s) shall furnish and install signs and/or graphics

as detailed on drawings and/or described in these specifications.

Refer to these performance specifications for details on designer expectations of Sign Contractor and fabrication process.

QUALITY ASSURANCE

- A. The Signage Contractor shall be responsible for the quality of materials and workmanship required for execution of this contract including the materials and workmanship of any firms or individuals who act as sub-contractors.
- B. It is intended that the work described in these documents be of sound, quality construction. The Signage Contractor shall be solely responsible for the inclusion of adequate amounts to cover installation of all items indicated, described and/or implied.
- C. Use only personnel thoroughly skilled and experienced with the products and methods for fabrication and installation of signage specified.
- D. Materials and hardware not specified, but necessary to the complete functioning of the sign, shall conform to the quality level established.

COMMENCEMENT

The work described in these documents shall only begin when a purchase order has been issued to the Signage Contractor with instructions to proceed, provided other requirements have been met.

CONTRACT ADMINISTRATION

Reviewing the quality and progress of the work and submittals received from the Signage Contractor, the Owner has no responsibility to assist the Signage Contractor in the supervision or performance of work. No action by the Owner shall in any way relieve the Signage Contractor from the responsibility for the performance of the work in accordance to the contract documents, or give rise to any negligence or other action against the Owner or anyone acting for their behalf.

Signage Contractor shall allow Owner or an authorized representative (Designer) access to his plant, excluding such areas or processes judged by the Sign Contractor to be proprietary in nature for the purpose of inspecting production techniques, materials, or other items related to the manufacturing of which the Owner is committed, or which may be contemplated.

Upon notification from the Signage Contractor that the work is complete, the Owner or authorized representative (Designer) will inspect the final installation for compliance with all approved documents.

RETAINAGE

The provisions and conditions governing retainers are provided in the contract documents of the Owner. All payments and invoices shall be submitted to the Owner for initial approval. The Owner will review all invoices for accuracy and completion of work.

ARTWORK

The Signage Contractor will produce all artwork for all symbols and lettering, and will submit to the Designer for review prior to fabrication. Artwork for specific items and logos, as noted on the drawing documents, shall be provided electronically by the Designer. All other artwork, as well as final artwork for final fabrication (including reproducible film positives) is to be provided by the Signage Contractor.

FIELD DIMENSIONS

Field dimensions shall be taken by the Signage Contractor prior to preparation of shop drawings and fabrication where possible. Time shall be allowed for trimming and fitting wherever the taking of field measurements before fabrication might delay work. Sign Contractor is to alert the Designer if a particular sign type or location does not fit per the Design Intent.

PARTS

All supplementary parts necessary to complete each item shall be furnished by the Signage Contractor. Even though such parts are not definitely shown or specified, all anchors and other fasteners for securing work shall be included.

SIGN CONTRACTOR RESPONSIBILITY

The graphic design requirements shown by the details on the sign drawing documents are for design intent only and intended to establish basic dimensions of units or modules, profiles and sight

lines of members, and appearance. Within these limitations, the Signage Contractor is responsible for fabrication of the entire system, and to make whatever modifications of and additions to the details as may be required. Maintain the visual design concept as shown including members sizes, profiles and alignment of components as accurately as possible.

The Signage Contractor shall supplement the general design shown with detailed shop drawings for (CSU Project Manager/Interior Designer) and Designer's approval. The shop drawings shall include major aspects of the system proposed, such as sections, shapes and connections of components and joints, how temperature movement is handled, venting, and anchorage to structure.

STATEMENT OF APPLICATION

The Signage Contractor, by commencing the work of the project, assumes overall responsibility, as part of his warranty of the work, to assure that all assembled components and parts shown that are required within the work of this project comply with the contract documents. The sign contractor shall fully warrant:

- A. That all components specified, or required, to satisfactorily complete the installation, are compatible with each other and with the condition of installed and expected use.
- B. The overall effective integration and correctness of individual parts and the whole system.

SECTION 5

- C. Compatibility with adjoining substrate, materials and other work by other trades.
- D. There shall be no premature material failure due to improper design of fabrication of the system. All materials are to fully perform to their normal life expectancy.

STATEMENT OF EXECUTION

The Signage Contractor shall be responsible for all work done under this contract, including:

- A. Faulty or improper work of subcontractor(s) and others under him by contract or otherwise.
- B. Diligent execution of work and giving personal attention and supervision to the same until complete.
- C. All delays caused by neglect on the part of the Sign Contractor or those under him by contract or otherwise.
- D. Compliance with all laws, ordinances and regulations bearing on the conduct of the work as drawn and specified.
- E. Obtaining, at the Sign Contractor's own cost, inspection certificates which may be required of the project by local authorities, or any other governing body. The Signage Contractor shall procure and pay for all permits, licenses and approvals necessary for the execution of the work.
- F. Applicable Engineering Stamps: On all drawings which are

intended to convey engineering information and services, a title block should be provided. The title block should contain:

1. The name and location of the firm providing the engineering services;
2. The name of the project and project location;
3. The client for whom the services have been provided;
4. The date the work was completed.

In addition, the title block may contain identification of those who prepared and checked the documents, as well as drawing numbers and such similar incidental items as are customary. Similar information shall be provided on the title page of all specifications and reports

Engineers should legibly indicate their name and business address on all engineering documents. Engineering documents which are issued for preliminary or conceptual use shall clearly note the intended purpose of such documents. When elements of the project are shown on an engineering document only for information or clarification and the Engineer does not intend to accept responsibility for the elements, the engineer shall clearly note on the documents the extent of his/her responsibility.

Engineers should clearly note on any preliminary engineering documents that such docu-

ments are not in final form, but are being transmitted to the public agency for review, comments and interpretations. The documents may subsequently be revised by the engineer to reflect resolution of issues with the public agency prior to final action by the agency. Changes, revisions and modifications to a project may prompt additional document submittal for agency approval action on the same project.

SPECIAL INSTRUCTIONS

Signage contractor shall halt the graphics work when notified of a proposed change, or unsatisfactory results are anticipated. Signage contractor shall notify the Owner or authorized representative immediately and proceed only after receiving additional instructions from the Owner or authorized representative.

PROTECTION & HANDLING OF PRODUCTS

Signage contractor shall store all graphic items under cover and off ground; handle in such manner as to protect surfaces and to prevent damage during storage, transport, installation and throughout remaining construction; protect exposed finishes by covering with adhesive paper or other suitable covering where adhesive is not appropriate for finish material; and apply covering prior to shipment from the fabricator or finishing shop. The covering shall not adversely affect finish. Signage contractor shall remove protective coverings when there is no longer

any potential for damage to the graphics work from other work yet to be performed.

SHIPPING & TRANSPORTATION

Signage Contractor will be responsible for proper shipping and transportation of all signage to the job site and will specify whether it will be common carrier or their own trucks. Signage Contractor will be liable for all damage incurred during shipping and loss of time in the installation schedule.

STORAGE OF EQUIPMENT

Space for storage of material prior to installation will be designated by the Owner. The Signage Contractor must give advance notice of deliveries and space requirements so the proper provision may be made. If deliveries are to be made to the premise at times other than normal working hours, the Signage Contractor will be required to reimburse Owner for any overtime costs incurred by Owner.

WARRANTY

Upon final completion, the Signage Contractor will warrant all work and materials to be full and complete in accordance with the contract documents and the agreement between Owner and Signage Contractor, and requirements appertaining thereto; that all work and materials are free from any and all defects and imperfections, and fully meet the manufacturer's published performance criteria for use and purposes for which each and every part is specified.

The Signage Contractor also agrees that, should any defect develop

or appear, which the Owner finds was not caused by improper use, the Signage Contractor shall promptly, upon demand, fully correct, substitute and make good any such defective material without cost to the Owner and will save the Owner harmless against any claim, demand, loss or damage by reason of any breach of this warranty.

The period of this warranty shall commence on the date on which the Owner determines the Signage Contractor has met all Final Completion requirements. The period of said warranty shall last twelve (12) months unless otherwise specified.

SUBMITTALS

By the approval and submission of shop drawings and samples, the Signage Contractor thereby represents that he has determined and verified all field measurements, including heights, field construction criteria, materials, catalogue numbers and similar data or will do so, and that he has checked and coordinated each shop drawing and sample with the requirements of the work and the contract documents. All submittals and shop drawings are to be submitted through the General Contractor to the Owner/Project Manager for distribution.

A detailed graphic schedule by phases of production and installation is to be submitted by the Sign Contractor within five (5) business days of receiving CSU's purchase order

Samples: Submit (1) 3" x 3" sample of each material, color and finish

SECTION 5

of exposed materials, accessories and fasteners, or final material substrate to be used in the project.

Copy Layouts: Copy layouts are to be provided for each sign type. Submit scaled drawings of typical sign faces showing copy layout. For multiple message sign types, a typical of each variation to the original layout should be provided.

Manufacturer's Data: Signage Contractor shall submit (1) copy of the manufacturer's printed specifications, anchorage details and installation, and maintenance instructions for all products to be used in the fabrication of signs and graphics work.

Shop Drawings: Submit (1) one copy of electronic shop drawings in 11" x 17" format for the manufacturing, fabrication and erection of signs and graphic work at large scale. Show joints, anchorage, accessory items, and finishes.

- A. Acceptance of shop drawings does not in any way change the documents. Documents may only be changed in writing.
- B. The Signage Contractor is responsible for reviewing shop drawings for conformance with the Design Intent documents and notifying, in writing, the Owner and Designer of any variation from the documents.
- C. Changes to the shop drawings are to be made by the Signage Contractor as directed by the Architect/Designer.

SUBSTITUTIONS

Any substitution requested will be considered under these cases:

- A. When specified product is not available.
- B. When certain product or process is specified, a warranty of performance is required, and, in the judgement of the Signage Contractor, the specified product or process will not produce the desired results.
- C. When such substitutions are in the best interest of the Owner.

The Sign Contractor shall furnish with the request for substitution such drawings, specification samples, performance data and other information as may be required of him to assist the Owner and Designer in determining whether the proposed substitution is acceptable. The burden of proof shall be upon the Signage Contractor that the proposed substitution:

- A. Is equal in quality and serviceability to the specified item;
- B. Will not entail changes in details and construction related to work;
- C. Will be acceptable in consideration of the required design and artistic effect;
- D. Will provide cost advantage to the Owner.

Proposed substitutions will be made after the apparent successful bidder has been selected and not during the bid phase. Signage Contractor shall submit requests for substitutions to the Designer

in writing with the first round of shop drawings, giving sufficient information and samples for evaluation with the differences in costs, if any. Substitutions must be approved in writing by the Owner and Designer before they may be used.

PRODUCTS OF FABRICATION

Shop fabrication and tolerances shall conform to the standards of the industry. Perform high-quality, professional workmanship. Attach materials with sufficient strength, number and spacing not to fail. Fabricate all work to be truly straight, plumb, level and square and to sizes, shapes and profiles indicated on the approved shop drawings.

MATERIALS & WORKMANSHIP

- A. The contractor shall use, whenever possible, standard sizes and readily available materials to reduce cost of fabrication. All materials shall be of the highest quality and shall meet all industry standards. To establish a standard quality, design and function desired, portions of the Design Intent Documents and specifications may be based on products or manufacturers herein. When specific products are mentioned, it should be noted that the manufacturers of similar products may be considered for approvals as "equal" by the Designer upon receipt of adequate supporting data.
- B. All materials utilized for the work of this contract shall meet all applicable codes, including

Fire and Life Safety codes, of authorities having jurisdiction over the projects. The Sign Contractor shall immediately report any discrepancies to the Designer for resolution. The Contractor shall not substitute products without obtaining prior written approval from the Owner and Designer.

- C. All sign faces shall be smooth and even, free from imperfections and disfiguring caused by such things as welding, material being too thin, fasteners and welds not being ground smooth, oil canning, staining, discoloration or uneven coloration, puckering, or any other problems not specifically mentioned herein.
- D. Climate conditions of the project site must be considered and the sign units designed and engineered to prevent problems caused by weather, expansion, contraction, condensation, and any other possible problems resulting from exposure to the elements.
- E. Weep holes, heat vents, etc. shall be considered for incorporation by the Sign Contractor on each sign type as required and/or necessary. Weep holes, vents, access panels and other functional, but non-aesthetic, components must be placed so as to be inconspicuous as possible. All such items must be shown on the shop drawings for approval prior to fabrication.
- F. All finish work shall be smooth

and free from abrasion, tool marks, visible welds, exposed fasteners or similar defects. All corners, reveals and joints shall be milled to matching adjoining pieces and shall be fabricated so that they are straight and/or configured to match the Design Intent Documents.

- G. Defective workmanship of any type shall not be tolerated and will result in rejection of the supplied product.

SYSTEMS PERFORMANCE REQUIREMENTS

Engineer, fabricate and install signs to meet Performance Requirements included in these Specifications and the following criteria:

- A. Code Compliance: Work, including structural loading, shall comply with all applicable Federal, State and Local Codes and applicable regulations of authorities having jurisdiction including ADA compliance.
- B. Design Criteria: The Drawings and Specifications indicate sizes, colors, layouts, profiles, critical details and dimensional requirements of signs.
- C. Windloading: All sign types and supporting devices, anchorage, etc. must be designed to withstand a wind speed of 100 mph on the total sign area applied in all directions and comply with all applicable codes.
- D. Thermal Movement Temperature Change (range): 120 degrees Fahrenheit ambient, 180 degrees Fahrenheit material surfaces.

SECTION 5

- E. Control of Corrosion: Prevent galvanic action and other forms of corrosion by insulating metals and other materials from direct contact with incompatible materials.

ARTWORK

Artwork for specific signs, logos and symbols, as noted on the drawing documents, shall be provided electronically by the Designer on disk or via FTP for the contractor's use in producing electronically cut type, images, patterns. This is the only acceptable source of art. Do not use artwork included as part of these Documents for final photography or digitizing. All other artwork, including final layouts for fabrication, is to be provided by the Signage Contractor for review by Designer.

TYPOGRAPHY & GRAPHICS

- A. The typefaces for this project shall be indicated on Page 10 of the design intent drawings.
- B. Sign Contractor shall report any discrepancies or conflicting sign specifications, such as message too long for specified format, to the Designer for resolution.
- C. Sign Contractor shall not use artwork included as part of these Documents for final photography or digitizing.
- D. All fonts specified must be purchased by the Sign Contractor for use in this program.
- E. All final output or implementation of typography and graphics are to be sharp (without serrated or irregular edges) and

exactly true to the letter style and/or design form.

- F. Sign Contractor shall allow for hand kerning of messages, at no additional cost, in which letters and numbers, although adequately spaced, appear to the Designer to be less readable, or unsatisfactorily spaced.

DIGITAL GRAPHICS

Use opaque continuous tone photo print - 5,000 DPI per sq. inch. Applied graphics should securely adhere to sign surfaces, and be applied smoothly: free of peeling, bubbling or other application defects. Graphics are expected to resist peeling and hold to applied surfaces. All digital graphic prints to be UV resistant and suitable for exterior use under direct sunlight.

COLOR

- A. Provide products matching those listed on Page 12 in both color and quality. For colors requiring a match provide paint products which best match the Pantone® swatch specified. Samples shall be submitted in accordance with the requirements listed above for approval prior to fabrication. Color breaks that occur on the sign face are to be sharp even, with no serration or color bleed. All splatters, drips, spills and over sprays shall be removed.
- B. Consult the Design Documents to ascertain all sign components to receive color.
- C. Coatings are to accurately match the color specified. The

number of coatings must be adequate to achieve the color specified. Three (3) samples of each color using the actual coating type must be submitted for approval prior to production, in accordance with the Submittals section of these Specifications.

FINISH

- A. All coating applications are to be smooth and consistently uniform. The cured coating surface is to have a uniform finish that matches the specified color and finish.
- B. Exact identification of all coatings and a description of the method of application shall be identified in the Shop Drawings.
- C. Color breaks that occur on the sign face are to be sharp, even, with no serration or color bleed. All splatters, drips, spills and over sprays shall be removed.

SCREEN PRINTED MEDIA

- A. All screen-printed graphics shall be produced with ABS paint compatible with the substrate, using mesh of 390 or finer to produce clean, sharp edges.
- B. All media are to be opaque, with full even coverage, and free from dust bubbles, blemishes and other foreign matter.
- C. There shall be no streaking created by drawing squeegee over screen.

MASONRY, CONCRETE, CAST STONE & NATURAL STONE

- A. Scope: The Contractor shall furnish all labor, materials, tools,

equipment and scaffolding, transportation, cartage, etc., required for the complete installation of all masonry as shown on the drawings and specified herein.

- B. Built-in Items: The Contractor shall build into the masonry, where required, all bolts, anchors, inserts, and the like.
- C. Protection : Masonry work shall be protected from freezing and from the elements at all times. The tops of masonry walls shall be covered at nights and at other times as required when not being worked on, with a waterproof covering to prevent water from entering the wall.
- D. Workmanship: All masonry work to be built up with true and even surfaces to proper heights, dimensions and forms, and carefully plumbed and leveled in all cases. All work is to be carried up continuously insofar as practicable.
- E. Performance: All exterior masonry construction shall be so built that it will be completely weather-tight and for a period of one (1) year from the completion and final acceptance of the building, the Masonry Contractor shall so guarantee.

VINYL

- A. Provide high performance vinyl film as indicated on the Drawings, 2 mil maximum thickness, with pressure sensitive adhesive, suitable for outdoor application to vinyl, painted surfaces, and

metal applications. All machine cut vinyl typography and graphics are to be on high-grade self-adhesive 2 mil maximum high performance, cast vinyl films with a minimum of (7) years durability or approved equal (or otherwise noted). The application of the vinyl characters is to be smooth, without bubbles, ridges or other imperfections. All vinyl typography (including letters, arrows, numbers, symbols, logos, etc.) shall be digitally reproduced, and machine cut.

- B. Surface coatings should be allowed to dry a minimum of 3 to 4 days before applying vinyl letters or graphics in order to avoid bubbles forming in the vinyl from out-gassing of the curing coating.
- C. Letters for sign panels are to have positionable pressure-activated gray pigmented adhesive to provide minimal color show through.

ALUMINUM & STEEL

Separation of Metals: There shall be no bare aluminum in contact with any other metals, wood or concrete. Contact surfaces shall be separated by a coating of zinc chromate and aluminum paint, or a heavy body bituminous paint or by a gasket.

PLASTICS

- A. Acrylic Sheet: Provide extruded plastic sheet, in sizes and thicknesses indicated suitable for exterior use and with UV blocker to protect printed artwork.

SECTION 5

- B. Rigid Foamed PVC Sheet:
Provide rigid foamed PVC Sheet (Komatex PVC-U) sheets in the sizes and thicknesses indicated. These sheets shall be impact and flame resistant. We are recommending the use of Komatex PVC-U over Sintra due to its compliance with regulations relating to the environment.

PAINTS/COATINGS/FINISHES

- A. Surface Preparation: Remove mill scale and rust, if present from uncoated steel and prime for painted finish.
- B. All coating applications are to be smooth and consistently uniform. The cured coating surface is to have a uniform finish that matches the specified color and finish.
- C. Color breaks that occur on the sign face are to be sharp even, with no serration or color bleed. All splatters, drips, spills and over sprays shall be removed.
- D. Exact identification of all coatings and a description of the method of application shall be identified in the Shop Drawings.
- E. Only highest quality 2-part catalyst-hardened acrylic polymer coatings are to be used. Color fastness is of utmost importance as well as quality and other assurances against abnormal deterioration such as peeling, cracking, crazing, etc.
- F. Coatings shall be prepared as designated by the manufacturers latest literature for surface preparation and application

but in no case less than one (1) applicable primer coat and two (2) final full coats. All finished surfaces shall be uniform.

- G. All coatings (paint, ink, etc.) should have UV inhibitors, and should not fade or discolor when exposed to ultraviolet light.
- H. Protect mechanical finishes on exposed surfaces from damage by applying strippable, temporary protective covering before shipping.
- I. All paint finishes are to be satin unless otherwise noted in the Design Drawings.

FASTENERS

- A. Use concealed fasteners fabricated from metals that are not corrosive to the sign material and mounting surface. All dissimilar materials must be separated from contact with each other. Fasteners shall be compatible with adjacent materials and substrates. Paint fasteners color of background if they cannot be concealed.
- B. Use nonferrous metal or hot-dipped galvanized anchors and inserts for exterior installations and elsewhere as required for corrosion resistance. Use expansion bolts or other fastening devices for drilled-in-place anchors designed to withstand all required loads. Furnish inserts, as required, to be set into concrete or masonry work.

FABRICATION

Signage Contractor shall provide sign copy to comply with the requirements indicated for size, styles, spacing, content, positions, materials, finishes, and colors of letters, numbers and symbols, and other graphic devices and construct to accurate details and dimensions as shown, and as reviewed on shop drawings. Exposed fasteners on finished sign faces will not be allowed, unless specifically indicated. Signage Contractor shall conceal wiring, conduit, and other electrical items within sign enclosures.

- A. Shop Assembly : Preassemble items in shop to greatest extent possible to minimize field splicing and assembly. Disassemble units only as necessary for shipping and handling limitations. Clearly mark units for reassembly and coordinated installation.
- B. Welding : All welding procedures shall conform to applicable AWS specifications. Type of alloy filler metal and electrodes to be that which is recommended by producer of metal to be welded, and as required for color match, strength and compatibility in the fabricated items.
- C. Flatness of Panels : Panels shall show no visible distortion when viewed in installed position.
- D. Cutting/ Routing : Cut and route in a manner to produce smooth, true, and clean edges and corners of finished graphics and letter forms. Graphics and letter forms having positive or

negative corners, nicked, cut or ragged edges are not acceptable. Align and maintain parallel baselines and margins as indicated on the drawings.

- E. Screen Printed Media : All screen printed media shall be produce with paint compatible with the substrate, using mesh of 305 or finer to produce clean sharp edges. All media is to be opaque with smooth even coverage and free from dust, bubbles, blemishes and other foreign matter. There shall be no streaking from drawing squeegee over screen.

EXECUTION

Quality and acceptability of the fabricators' work will be monitored throughout the fabrication and installation phases of the project. Work will be reviewed by the Designer.

- A. Shop Reviews: Contractor shall notify Designer at least 48 hours in advance of operations requiring reviews.
- B. Site Reviews: Upon arrival of any shipment of sign units or materials, the Sign Contractor shall inspect the shipment to verify that no damage has occurred that will adversely affect the performance or appearance of the units or materials. The Owner/Designer shall not accept, as approved, any units or materials previously rejected by the Designer and not repaired or revised to the Designers satisfaction.

- C. Sign Locations: The Sign Contractor shall field-verify all proposed sign locations in the field and conduct a walk-thru with the Construction Manager/Designer in order to obtain a written approval of the proposed locations before installation of the sign units. All locations must be permitted through the City's process (by Sign Contractor).
- D. Punch List: Immediately after installation of the signs, the Sign Contractor shall arrange for the Designer to review the work in place and give written notice of any deviations, errors, omissions or other unacceptable condition in a punch list to be prepared and distributed to the proper fabricators or consultants for correction.
- E. Final Sign-Off: At final completion of all work, including punch list items for each group of signs, the Sign Contractor shall arrange for a final review by the Construction Manager/Architect or Designer for the purpose of obtaining a written approval of the fabrication and installation of the units.

INSTALLATION

The installation of fixed materials shall be under the general direction of the Owner/Designer in accordance with applicable specifications and layout drawings.

- A. Preparation: Signage Contractor shall coordinate setting drawings, diagrams, templates, instructions and directions for

SECTION 5

the installation of items having integral anchors which are to be embedded in concrete. Signage Contractor shall coordinate delivery of such items to applicable trades for installation. Sign Contractor is also responsible for procuring any obstruction permits that may be necessary while installing within city streets and public right-of-ways.

- B. Delivery to Premise: Sign Contractor is responsible for securing staging and storage areas. Unless indicated to the contrary, items of loose material shall be delivered, uncrated, assembled, set in proper place and installed ready for use, free from breakage, blemishes or other defects.
- C. Anchors and Inserts: Signage Contractor shall furnish inserts and anchoring devices which must be set in concrete or built into masonry for installation of this work, provide setting drawings, templates, instructions and directions for installation of anchorage devices and provide units with exposed surfaces matching the texture and finish of metal item anchored.
- D. Cutting/Fitting/Placement: Signage Contractor shall perform all cutting, drilling and fitting required for installation, set work accurately in location, alignment and elevation, plumb, level and true, measured from established lines and levels, and provide temporary bracing or anchors as required.

Signage Contractor shall form tight joints with exposed connection accurately fitted with uniform reveals and spaces for sealants and joint fillers. Where cutting, welding and grading are required for proper shop fitting and jointing of the work, Signage Contractor shall restore finishes to eliminate any evidence of corrective work.

- Signage Contractor shall not cut or abrade finishes which cannot be completely restored in field. Signage Contractor shall return items with such finishes to the shop for required alterations, followed by complete refinishing or providing new units at Signage Contractor option.
- E. Erection: All surfaces shall be covered with protective non-deleterious to finish for protection until final installation or erection. Signage Contractor shall complete all connections in proper alignment and tighten bolts securely. Leveling is to be done only by instruments; measuring equal distances from existing surfaces will not be acceptable as a basis of level and/or plumb. After erection, all surfaces marred during erection and exposed bolts, bolt heads, etc., shall be retouched with same paint as previous.
- F. Protective Coverings: Sign Contractor shall restore protective coverings which have been damaged during shipment or installation of the work, remove protection when requested

for inspection of finishes and replace, retain protective coverings intact and remove simultaneously from similar finished items to preclude non-uniform oxidation and discoloration and remove protective coverings only when there is no possibility of damage from other work yet to be performed at the same location.

- G. Cleaning of Premises/Signs: The Signage Contractor shall use special care in the disposition of excess materials and rubbish. Rubbish shall not be allowed to accumulate but shall be consistently collected and removed at the completion of this work, on a daily basis. After installation, Signage Contractor shall clean soiled sign surfaces according to manufacturer's written instructions, protect signs from damage until acceptance of Owner and touch up all nicks, scratches, fasteners that require color.